

2021 Renegade®



Jeep®

these roots
have run deep
since 1941



BORN AS A PURPOSE-BUILT 4x4 FOR THE FRONT LINES OF WWII IN 1941, JEEP® 4x4s SOON TRANSITIONED FROM THE BATTLEFIELDS TO THE FARM FIELDS AND BACKROADS OF AMERICA, WHERE THEY KEPT UP WITH HARD DAILY USE IN INDUSTRY AND RECREATION ALIKE. THROUGH 80 YEARS AND ALL MANNER OF TERRAIN AND WEATHER, A GROWING LINEUP OF JEEP® 4x4s HAS CONSISTENTLY MOVED THE BAR WITH STRONG DRIVETRAINS, INNOVATIVE ENGINEERING AND QUALITY COMPONENTS THAT STAND OUT FROM ALL OTHER 4x4 SUVs.





FROM STOP TO GO

CAPABILITY

- Jeep® Brand Engineering
 - Available Trail Rated® Capability (Trailhawk® exclusive)
- Available Jeep Active Drive with Disconnecting Rear Axle (4x4 models)
- Available Jeep Active Drive Low with Hill Descent Control and 21:1 Crawl Ratio (Trailhawk exclusive)
- Available Selec-Terrain® Traction Management System (4x4 models)

DRIVETRAIN

- Available 1.3L 16V MultiAir®2 Turbo Direct-Injection Engine
 - 2.4L Tigershark® Engine
 - 9-Speed Automatic Transmission on Both Engines
- Available Engine Stop/Start (ESS) Technology
 - Up to 2,000-lb Towing Capability (when properly equipped) on 4x4 Models

STYLE

- Signature Seven-Slot Grille
- Signature Round Headlamps
- Gloss Black-Painted Roof (Trailhawk and Limited models)
 - Available 19-inch Aluminum Wheels
 - Available Dual-Pane Panoramic Power Sunroof

CONNECTIVITY

- Standard Uconnect® 4 with 7-inch Touchscreen Display
 - Apple CarPlay®1* iPhone® Compatibility
 - Android Auto™2 Smartphone Integration
 - Standard Siri® Eyes Free³
- Available SiriusXM® Radio⁴ including 6-Month Trial Subscription
- Available SiriusXM Guardian™5 including 1-Year Trial Subscription
- Standard USB and Auxiliary Port plus 12-Volt Power Outlet
 - Available Uconnect 4C NAV with 8.4-inch Touchscreen Display and GPS Navigation
- Available SiriusXM Traffic Plus⁶ including 5-Year Trial Subscription
- Available SiriusXM Travel Link⁶ including 5-Year Trial Subscription



Limited in Granite Crystal Metallic

TECHNOLOGY

- Standard Push-Button Start
- Available 7-inch Full-Color Driver Information Display (DID)
- Available Remote Start System⁷
- Available Keyless Enter 'n Go™
- Available LED Lighting Group
- Available Kenwood Premium Audio System

COMFORT

- Standard Dual-Zone Automatic Temperature Control (ATC)
- Available Leather-Trimmed Seats
- Available 40/20/40 Split-Folding Rear Seats with Pass-Through
 - Available Heated Front Seats
 - Available Heated Steering Wheel
- Available Ambient LED Interior Lighting

SAFETY & SECURITY

- Over 70 Standard and Available Safety & Security Features
- Seven Standard Air Bags,⁸ including Driver Knee Blocker
 - Standard ParkView® Rear Back-Up Camera⁹
 - Standard LaneSense® Lane Departure Warning with Lane Keep Assist¹⁰
 - Standard Blind Spot Monitoring¹¹ and Rear Cross-Path Detection⁹ Systems
- Available Full-Speed Forward Collision Warning with Active Braking¹²
 - Available Adaptive Cruise Control¹³
- Available Parallel and Perpendicular Park and Unpark Assist System¹⁴
 - Available ParkSense® Front and Rear Park Assist System¹⁴

*A note about this brochure: all disclosures can be found on the last page.

there's only one
here's yours



Limited in Slate Blue Pearl



1



2

room to move

Road trips are always exciting, just like the dramatic cabin design offered in Jeep® Renegade® Limited. This contemporary standard color palette enhances the cabin's spacious interior, where passengers have plenty of wiggle room to spread out and relax. Storage features are plentiful, so you can stash devices, tablets, cups and personal items safely out of the way.

All of the details are exceptional, like nicely cushioned leather-trimmed seats accented with attractive contrast stitching and an 8-way power-adjustable driver's seat with comforting power 4-way lumbar adjust. Also on Limited, heating on the front seats and a leather-wrapped steering wheel are standard.

1 and 3. Limited with Black / Ski Grey leather-trimmed seating
2. Limited in Alpine White



3



Limited with Black / Ski Grey leather-trimmed seating, tonal accent stitching and Grillz interior accents

technology-driven

Jeep® Renegade® Limited interior engages your appreciation of design and details with its clean, sculpted forms. Grillz and Metal Diamond bezels with chrome accents add upscale distinction. Standard LED ambient lighting sets an elegant tone. Drivers enjoy quick relief from the cold after taking hold of the heated steering wheel and relaxing in heated front seats, both standard on Limited. Fingertip controls on the steering wheel help keep eyes on the road while adjustments are made to entertainment and communication systems, vehicle speed, the standard 7-inch full-color Driver Information Display and more. Two USB ports, a 12-volt outlet, an auxiliary port and a 115-volt auxiliary power outlet help devices, computers, phones and tablets stay powered up and in play. Apple CarPlay^{®1} compatibility and Android Auto^{™2} integration are standard on every Renegade[®] model.

freedom, meet imagination



Jeep® Renegade® lets you see the world your way. Go from urban adventures to off-road discoveries with the unique comforts and powerful capabilities found in Jeep® Renegade®. With a face that's a recognized member of a legendary family, Renegade arrives with authentic Jeep Brand DNA engineered throughout. New standard safety and security systems are included in every trim level, including Blind Spot Monitoring¹¹ and Rear Cross-Path Detection⁹ Systems, and LaneSense® Lane Departure Warning with Lane Keep Assist!¹⁰ Two available 4x4 systems offer dependable all-weather fortitude to keep you moving in challenging conditions, while the rear-axle disconnect works intuitively to improve efficiencies. World-class driving dynamics, including independent front and rear suspensions with Frequency Selective Damping (FSD) shocks, help to deliver a smooth, controlled ride experienced within a cabin that's designed with the tech-savvy in mind.



DUAL VIEWS IN A DAY'S WORK

prepared for
opportunity



Designed to put more controls, data and storage up front and right at hand, this instrument panel and console help drivers and passengers connect with convenience as well as attention-getting style. The instrument panel glows brightly, with an available 7-inch full-color, customizable Driver Information Display front and center. The available Uconnect® 4C NAV with its 8.4-inch full-color touchscreen and GPS can be customized with both Android Auto™² and Apple CarPlay.^{®1}

The Luxury Group III raises the bar on Trailhawk® by adding upscale interior and exterior features with notable LED lighting. This robust collection of options includes premium leather-trimmed seats with Ruby Red accent stitching, LED cornering fog lamps, bi-function LED projector headlamps, LED taillamps and LED daytime running lamps (DRLs).

1. Trailhawk® in Glacier Metallic

2. Trailhawk with available Black leather-trimmed seating and Ruby Red interior accents



elevate the experience

Heighten all the senses with the standard features that enhance the interior of the Renegade® Trailhawk®. The unique Ruby Red interior accents and stitching are exclusive to this Trail Rated® master. The standard Uconnect® 4C NAV radio, with its large 8.4-inch full-color touchscreen, uses Apple CarPlay®¹ and Android Auto™² to import your smartphone's home screen, making it easy to access your apps and data. The heated front seats and steering wheel will forever become "must-haves."

1, 2 and 3. Trailhawk® with available Black leather-trimmed seating and Ruby Red interior accents



2

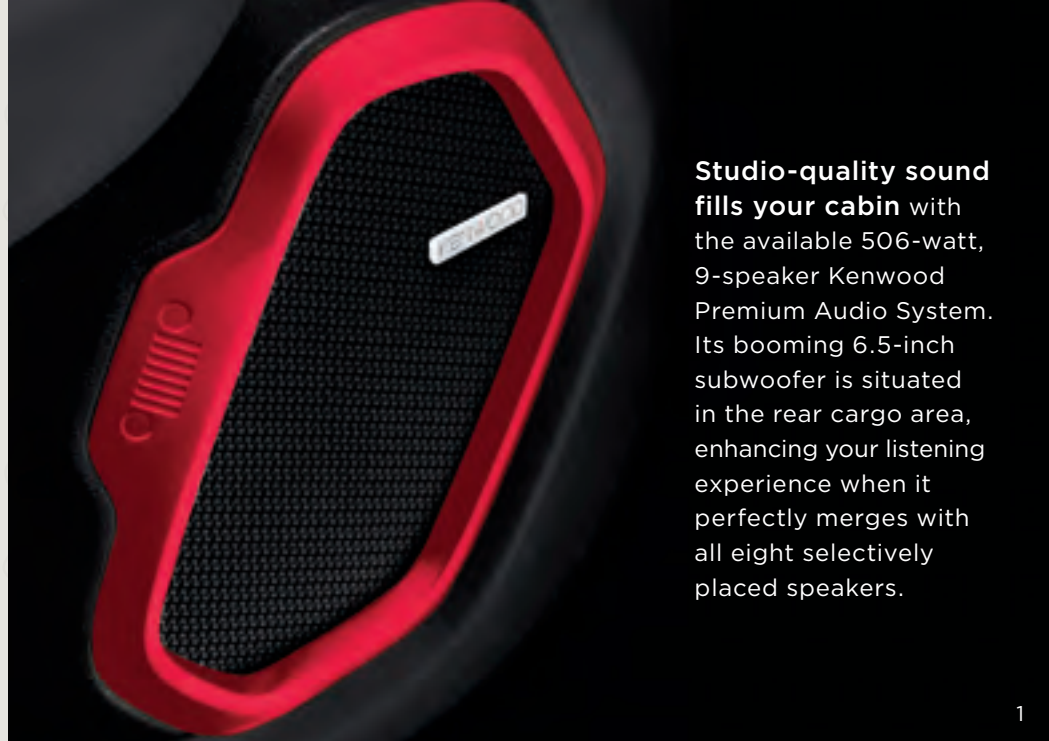

Studio-quality sound fills your cabin with the available 506-watt, 9-speaker Kenwood Premium Audio System. Its booming 6.5-inch subwoofer is situated in the rear cargo area, enhancing your listening experience when it perfectly merges with all eight selectively placed speakers.

1



Eight cup holders, located front, center and rear, help keep items accessible and tidy when equipped with the 40/20/40 split-folding rear seats. The front console also offers a special slot that's perfect for a phone or small tablet.

3

driver's data

A large, 7-inch full-color Driver Information Display sits front and center on the dashboard — a standard feature on Trailhawk,[®] Limited and Latitude models. It provides all kinds of information that drivers will find useful, including operations of safety and performance features, vehicle stats and much more. The 3.5-inch monochrome display is standard on Sport models.



in touch with technology

The Uconnect® 4C NAV radio includes an 8.4-inch full-color touchscreen that glows with crisp definition. Intuitive to use, the system lets you fully integrate your smartphone with Apple CarPlay®¹ and Android Auto™² while a full menu of SiriusXM Guardian™ connected services⁵ is yours to explore. This premium navigation system shows you the way to adventure, including route options and landmarks that let you take the long road to discovery. Standard on Trailhawk® and Limited models. Available on Latitude models.



KEYLESS ENTER 'N GO™

Simply keep your key fob in your pocket, grab the door handle and climb in. Once inside, start the engine by pressing the Start/Stop button while applying the brake. Standard on Trailhawk and Limited models. Available on Latitude models.

PUSH-BUTTON START

This feature pairs with your key fob. When you're seated and ready to head out, push on the brake, then push the "Start/Stop" button. The engine comes to life and you can shift into Drive and go. Standard.





IN TOUCH WHEREVER YOU GO

The Uconnect[®] system is your customizable, connected vehicle platform dedicated to safe and seamless communication, navigation and entertainment — all from one easy-to-use touchscreen.

Uconnect[®]

You're always connected with Uconnect, whether in your vehicle or via the app¹⁵ on your iPhone[®] or Apple Watch, which allows you to lock and unlock your vehicle remotely.

DRIVEUCONNECT.COM



8.4-inch Uconnect® Touchscreen Display

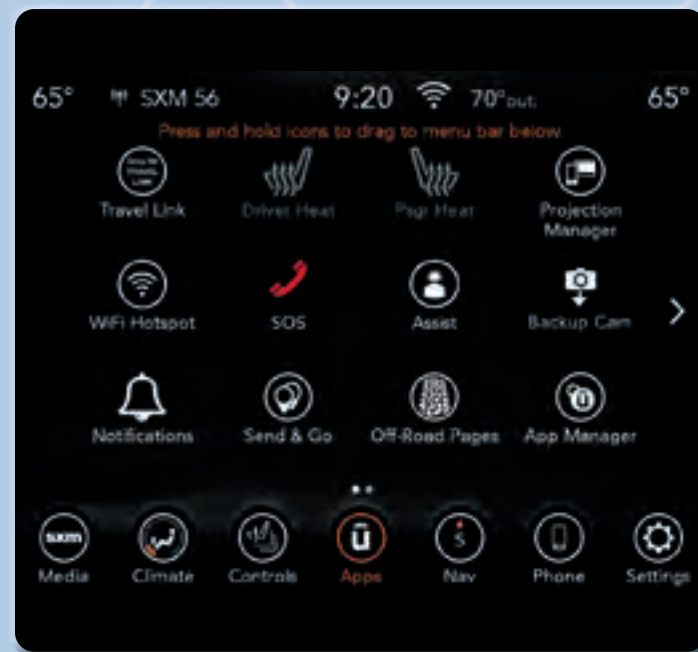

Drag-and-Drop Menu Bar

COMPATIBILITY YOUR WAY

Uconnect® brings a wide range of interactive features to your vehicle and beyond through a highly intuitive communication experience.

UCONNECT® PHONE

Stay connected safely. Pairs a Bluetooth® phone to send and receive hands-free¹⁶ calls. Includes:

- **DO NOT DISTURB** to route incoming calls to voice mail and suppress text messages¹⁷
- **VOICE RECOGNITION** to make hands-free¹⁶ calls, listen and respond to text messages,¹⁷ record voice memos, and select media stations and navigation destinations

DRAG-AND-DROP MENU BAR

We've made it easy to customize your Uconnect dashboard with your favorite features and services. Simply press the Uconnect icon on the main menu bar to view all of the available apps. Tap and hold any one of the icons to drag and drop into a personalized menu bar.

SIRI® EYES FREE³

Just say it. Use voice commands with Siri® Eyes Free³ and your connected iPhone® to create and send texts, make and receive calls, access directions, and play music. Standard.

ONE-STEP NAVIGATION

Take the best route right now. Uconnect employs GPS Navigation for audible turn-by-turn directions, and detailed 3D maps help to ensure you arrive on time. Use Voice Command and say the complete address to get directions quickly. Available.

4G Wi-Fi¹⁸ HOTSPOT

Along the way, you can upload, download, post and search. Connects to your personal Wi-Fi¹⁸ device for fast, reliable Internet for up to eight devices within 50 feet of your vehicle. Available.

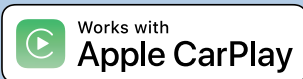

Display your favorite iPhone® apps right on your Uconnect® touchscreen. Access your iTunes® library, call anyone in your contacts list or just ask Siri®³ to help you out while you drive. Get directions, make calls and send messages, and connect to Apple Music, all without pausing your drive. Standard.



Bring the best of Google with you in your Uconnect system. Talk to Google on Android Auto™² and get things done with your voice so you can keep your focus on driving. Easily send messages, get directions, control media and more. Just say, "Hey Google" or long-press the voice control button on your steering wheel. Standard.



SiriusXM® Travel Link⁶



SiriusXM Traffic Plus⁶

Uconnect®

Trips are enhanced with informative and entertaining apps. Access them on your Uconnect® touchscreen as well as your smartphone. Connected technology keeps you linked to a whole new world.

(((SiriusXM®)))

Listen to your favorite playlist from your connected device, then flip to SiriusXM® Radio⁴ and enjoy the best commercial-free music, plus every major sport and the biggest names in entertainment, news and comedy. You'll get over 150 channels, all at the press of a button. With the SiriusXM All Access⁴ package, you get every channel available on your satellite radio, and you can also listen wherever you go on your portable devices with the SiriusXM App⁴, which is included with your six-month trial. Available.

SiriusXM TRAVEL LINK

Access useful information when you need it, right at your fingertips. Get detailed weather maps, five-day forecasts and severe weather alerts, as well as sports scores and in-game weekly schedules for your favorite teams, information on fuel prices in your area and more. Your first five years of SiriusXM Travel Link⁶ service are included. Available.

SiriusXM TRAFFIC PLUS

Avoid congestion before you reach it. Get continuous updates on traffic speed, accidents, construction, road closures and more before you begin your travels. You will get to your destination faster and more easily than ever before. Your first five years of SiriusXM Traffic Plus⁶ service are included. Available.

Uconnect® + SiriusXM GUARDIAN™

SIRIUSXM GUARDIAN™⁵ Drive worry-free with SiriusXM Guardian™⁵ — a premium suite of safety and convenience services that can be accessed in-vehicle or through the Uconnect® App.¹⁵ Includes a one-year trial. Available.

SIRIUSXM GUARDIAN⁵ SERVICES + UCONNECT® APP¹⁵

- SOS CALL¹⁹** In the event of an incident, push the SOS¹⁹ button. You'll be connected to a SiriusXM Guardian⁵ agent who will contact emergency services, provide your location and stay on the line with you until help arrives.
- ROADSIDE ASSISTANCE CALL²⁰** puts you in touch with an agent who can get you help while you're out on the road.
- LOCK/UNLOCK** your car from virtually anywhere.
- START YOUR CAR REMOTELY²¹** (not available on Sport models).
- FLASH THE LIGHTS** and sound the horn to help find your car.

VEHICLE FINDER²² allows you to locate your vehicle on a map.

SEND & GO²³ enables you to send destinations to your navigation system.

THEFT ALARM NOTIFICATION²⁴ Receive alerts by text, email or push notification if your vehicle's available theft alarm is triggered.

- STOLEN VEHICLE ASSISTANCE²⁵**
- FAMILY DRIVE ALERTS²⁶** Peace of mind when you hand over the keys. Allows you to set parameters to receive notifications when others are operating your vehicle.
 - BOUNDARY ALERT.** Be alerted the moment your vehicle is driven out of up to five geographic boundaries that you set.
 - CURFEW ALERT.** Be alerted if your car is being driven outside of the curfew you set.
 - SPEED ALERT.** Receive a notification whenever your car exceeds a speed limit you set.
 - VALET ALERT.** Be alerted the moment your vehicle is driven outside of a defined radius.

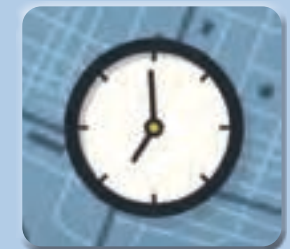
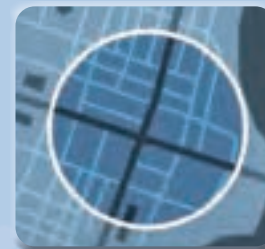

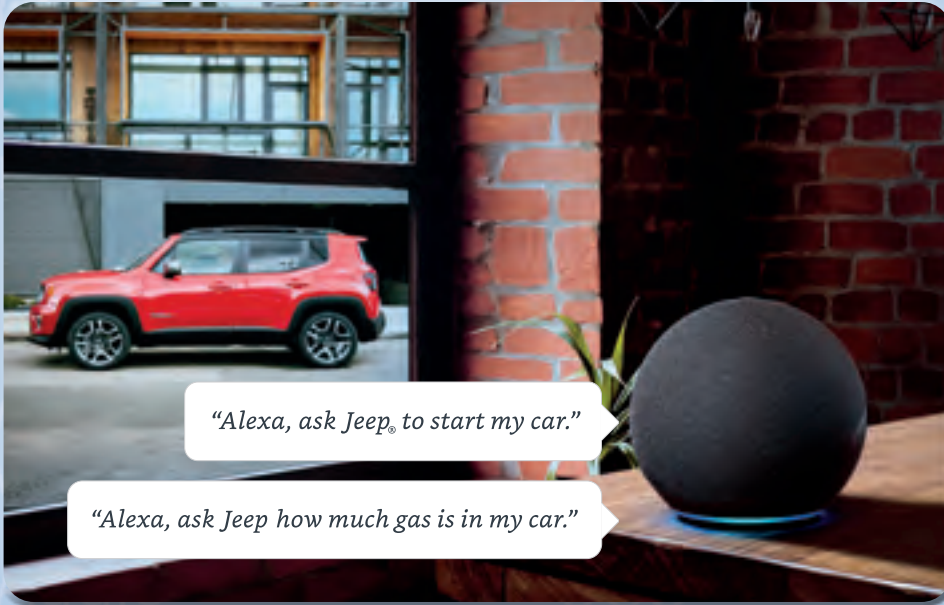

Conveniently command your vehicle using your voice with the Jeep® Skill²⁷ for Amazon Alexa on an Alexa-enabled device from the comfort of your home! Just ask Alexa to start/stop the engine, lock/unlock the doors, check fuel status or tire pressure and more. With available Uconnect® Navigation, you can also ask Alexa to find a business and send the address directly to your vehicle.



CLICK HERE TO GET THE JEEP SKILL²⁷ FOR AMAZON ALEXA

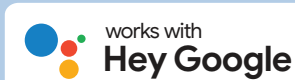

Remotely voice-control your vehicle from any Google Assistant-enabled device with the Jeep Action on Google. Simply ask Google to start/stop the engine, lock/unlock the doors, check fuel status or tire pressure and more. With available Uconnect Navigation, you can also ask Google to find restaurants, gas stations and other destinations and send the addresses directly to your vehicle for added convenience.



CLICK HERE TO GET THE JEEP GOOGLE ACTION



ACCOMMODATE ADVENTURE

An aerial photograph of a red SUV driving through a river in a forest. The car is positioned in the lower center of the frame, moving towards the bottom right. The water is dark and turbulent, with white foam around the car. The surrounding forest is dense with green trees, and there are patches of snow on the banks. The text "remote possibilities are now your 'go-to'" is overlaid in white, sans-serif font in the upper left quadrant.

remote possibilities
are now your "go-to"



Trailhawk® in Colorado Red
Properly secure all cargo

take on the world

Inner versatility. Being practical can also be fun, and with its functional interior features, Jeep® Renegade® is fully prepared. Its interior works hard to make room for traveling, with an available height-adjustable rear cargo floor and a standard fold-forward front-passenger seat. Available ambient LED interior lighting helps you see where items are stored while setting the mood for fun.

The 60/40 or available 40/20/40 split-folding rear seats with pass-through accommodate all kinds of cargo and passenger configurations. Bring any combination of people, pets and luggage. Then, head for parts known, unknown and all points in between.

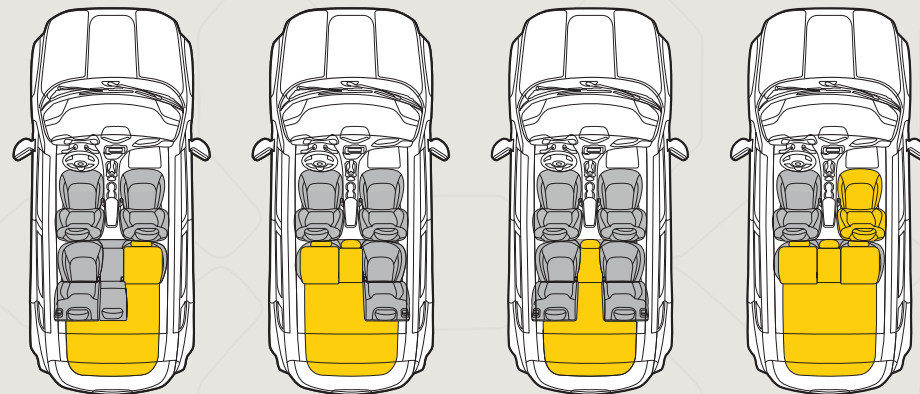



make room for more

Designed to adjust to your cargo-carrying needs. You're able to load up for big trips, whether they're to the corner grocery store or to your favorite camping spot. A generous rear cargo area offers up to 50.8 cu ft of space with the rear seat folded down, for a full interior volume of 118.6 cu ft.

1



2



3

1. Trailhawk® with available Black leather-trimmed seating and Ruby Red interior accents 2. Adjustable cargo floor shown raised for easy slide-in loading 3. Lower the floor to gain additional space to accommodate taller items



smart superpowers



Efficient and adventurous,

Jeep® Renegade® grants you access to places others only dream of reaching. Jeep Brand capability helps keep you moving forward whether fording²⁸ through water or traveling over tough terrain, while the efficiencies found in small SUVs help keep your budget in check so you can travel far and wide.



room to play nice

Trailhawk® seats five comfortably, with a spacious cabin and a wide range of fine-tuned standard features. It merges a sporty interior design with an 8-way power driver's seat with 4-way power lumbar adjust, heated leather-wrapped steering wheel and heated front seats, 40/20/40 split-folding rear seats with a pass-through to the cargo area, auto-dimming rearview mirror, all-season floor mats, tonneau cargo cover and more.

Trailhawk® with available Black leather-trimmed seating and Ruby Red accent stitching



display your adventurous nature

Trail Rated® Every Jeep® Brand vehicle bearing a Trail Rated® badge is designed and built to Go Anywhere, Do Anything® and to perform with exceptional 4x4 capability. Each must successfully pass tests in five performance categories: Traction, Articulation, Maneuverability, Ground Clearance and Water Fording.²⁸ Standard on Trailhawk®.

Your Trail Rated Renegade® Trailhawk arrives hardwired with the hardware that includes the Jeep Active Drive Low 4WD System and a set of skid plates that help protect your vehicle's most vulnerable parts when you're traveling over tough terrain. Rise to the greatest heights of on- and off-road mastery with Jeep Renegade. This renowned and capable SUV boasts an elite pedigree born of legendary strength and timeless style.



manage your grip on the ground

The Selec-Terrain® Traction Management System quickly tailors your traction control with the turn of a dial. In an instant, you've got the right amount of grip and capability for the type of terrain you're facing. By coordinating many vehicle systems, you're able to navigate the most challenging conditions with ease. Dial settings include Auto, Snow, Sand, Mud and, exclusive on Trailhawk®, Rock mode.



auto

In this mode, Selec-Terrain does all the work, automatically adjusting vehicle dynamics to best suit the road. To help ensure optimal efficiency, the rear driveline disengages when not needed.

snow

Adjusts for ultimate performance over snow- and ice-covered roads by maximizing vehicle stability and minimizing oversteer. Major systems auto-engaged and managed in this mode include antilock brakes and traction control.

sand

Converts to a uniquely calibrated Sand mode that utilizes an aggressive throttle and up-shift points to tackle looser, sand-covered surfaces.

mud

Maintains low-speed traction by allowing additional wheel-slip via specifically tuned chassis controls, differentials and transmission ratios that are geared to successfully tackle mud.

rock

Exclusive to Trailhawk, Rock mode delivers low-speed 4x4 capability thanks to its rear-differential locking element. This allows Jeep® Renegade® to command the world's most challenging terrain.

4x4



RENEGADE® 4x4 SYSTEMS

Jeep® Active Drive Put your capability on automatic pilot. This available 4x4 system does the work for you, targeting exactly when you need a boost of traction. It features a single-speed Power Transfer Unit (PTU) that combines proven Jeep® Brand capability with welcome efficiencies to deliver a double whammy of 4x4 prowess and efficiency. Jeep Active Drive can seamlessly transition from FWD to 4WD and back again, thanks to the system's smart rear-axle disconnect that operates in tandem with the available Selec-Terrain® Traction Management System's Auto mode. Under normal driving conditions, the front wheels provide most of the traction. But, should the front wheels start to lose grip, power automatically transfers to the rear wheel(s), so you seamlessly maintain optimal traction without having to take additional action.

Jeep Active Drive Low This system gives Trailhawk® its superpowers to easily conquer tough ridges, rocks and weather or the extra determination to pull a boat out of a lake. This one-speed system features Hill Descent Control that adds extra control over throttle, speed and braking, allowing you to smoothly travel down steep hills. Dial in to Rock mode when you need the boost of a 21:1 crawl ratio. Exclusive to Trailhawk.

fearless performance



1.3L MULTIAIR®2 TURBO 4-CYLINDER ENGINE Its direct fuel injection helps to deliver 177 hp and 210 lb-ft of torque to push the envelope of towing power while handing over welcome fuel efficiencies, with up to 32 hwy mpg.²⁹ Engine Stop/Start (ESS) Technology helps improve fuel efficiency. Available active grille shutters open and close automatically to help control the flow of air, reducing drag and helping to maximize mpg performance. This turbo engine is standard on Limited and Trailhawk® models and available on Latitude models.

2.4L TIGERSHARK® MULTIAIR2 I-4 ENGINE Engineered to deliver the best of both worlds: a quiet and refined performance backed by the ability to power through tough terrain. Its 180 hp and 175 lb-ft of torque hand over its power whenever requested. This fuel-efficient workhorse is standard on Sport and Latitude models.

9-SPEED AUTOMATIC TRANSMISSION Shifting gears with a precision that's as smooth as silk. The gears are fine-tuned with a ratio spread of 9.81 to ensure quick takeoffs and a consistently refined performance. Exceptional efficiencies are produced through all gears at all speeds. Standard with both engines.

FUN IN TOW Expand your options by adding the available Trailer Tow Group and you're able to bring along a ton of toys, literally. The Class III hitch receiver and 4-pin wiring harness have a capacity to tow up to 2,000 lb. Available with both engines.



Properly secure all cargo

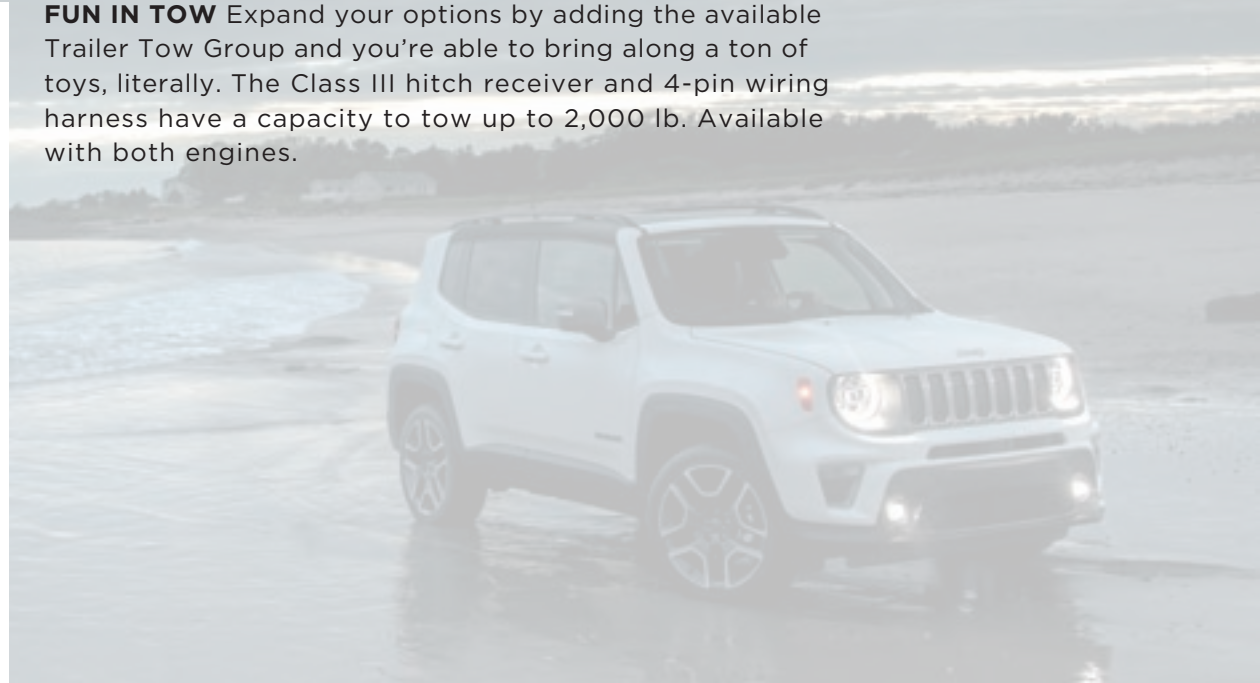

heroic standards

SAFETY & SECURITY

When it comes to standard features in safety and security, the benchmark is raised for Jeep® Renegade®. Every model arrives with Blind Spot Monitoring¹¹ and Rear Cross-Path Detection⁹ Systems, and LaneSense® Lane Departure Warning with Lane Keep Assist.¹⁰ With an array of available sensors keeping watch of your perimeter and a cabin engineered with seven standard air bags,⁸ Renegade acts as your constant guardian when you're behind the wheel.

LANESENSE® LANE DEPARTURE WARNING WITH LANE KEEP ASSIST¹⁰

Provides a visual and audible warning and steering-wheel movement should the vehicle drift outside of lane boundaries or if the driver's hands are off the wheel. Standard.

FULL-SPEED FORWARD COLLISION WARNING WITH ACTIVE BRAKING¹²

Should you approach another vehicle too rapidly, you'll get audible and visual alerts and brake assistance if reaction time is too slow. Available.

ADAPTIVE CRUISE CONTROL¹³

Take the guesswork out of keeping a safe following distance from the car ahead while cruising on the highway. When activated, the system automatically adjusts cruising speed to maintain a preset distance between you and the vehicle ahead. Available.

AUTO HIGH-BEAM HEADLAMP CONTROL

Sensors eliminate the need to manually turn off high-beams when oncoming traffic approaches. Available.

ELECTRONIC STABILITY CONTROL (ESC)³⁰

A vehicle-wide network of safety sensors helps maintain vehicle control, providing instant aid should they detect you're veering off your intended path. ESC³⁰ coordinates Electronic Roll Mitigation (ERM), Antilock Brake System (ABS) and Advanced Brake Assist, All-Speed Traction Control, and Trailer Sway Control (TSC).³¹ sending them into action when needed. Standard.

PARALLEL AND PERPENDICULAR PARK AND UNPARK ASSIST SYSTEM¹⁴

This active guidance system controls steering automatically. You can take your hands off the steering wheel and let the system's ultrasonic sensors help you ease into parking spots as you gently brake and change from Reverse to Drive as needed. Unpark Assist¹⁴ helps you navigate your way out of parking spots. It controls the vehicle's steering while providing the driver with gear and braking instructions. Available.

PARKVIEW® REAR BACK-UP CAMERA WITH ACTIVE GRID LINES⁹

This system helps bring previously hidden rear objects to your attention on-screen in good time to react. Standard.

PARKSENSE® FRONT AND REAR PARK ASSIST SYSTEM¹⁴

This system uses sensors to alert the driver with audible and visual warnings when objects come in close proximity to the front or rear of the vehicle. Assists with Parallel and Perpendicular Park and Unpark Assist System.¹⁴ Available.

BLIND SPOT MONITORING¹¹ AND REAR CROSS-PATH DETECTION⁹ SYSTEMS

Maintain a safe perimeter with the help of these sensor systems. Chimes and illuminated icons notify you when side or rear blind spots are encroached. Standard.



SAFETY & SECURITY

KEYLESS ENTER 'N GO™ Simply keep your key fob in your pocket, grab the door handle and climb in. Once inside, start the engine by pressing the Start/Stop button while applying the brake, shift into gear and go. Available.

LED LIGHTING To provide you with the clearest visibility, LED lights and other features are gathered together into special luxury groups. You'll have a full complement of LED lights, including headlamps, daytime running lamps (DRLs), taillamps and fog lamps. Available.

A SECURE AIR BAG® SYSTEM Full-length front and rear side-curtain, driver inflatable knee bolster, seat-mounted side for front occupants, and advanced multistage driver and front-passenger air bags⁸ all work together to help provide encompassing protection. Standard.

CHASSIS STRENGTH Maintain peace of mind with this strong safety cage, constructed with high-strength steel. Exceptional ride quality is experienced as well. Standard.

TRAILER SWAY CONTROL (TSC)³¹ Crosswinds and traffic hold no sway over you and your payload. As part of Electronic Stability Control (ESC),³⁰ TSC³¹ helps keep you and the toys you tow safely on course. Standard.

RAIN-SENSITIVE WINDSHIELD WIPERS Storm clouds hold little influence over your daily drive. Front wipers activate when raindrops are detected. Available.

WINDSHIELD WIPER DE-ICER Maintain a clear view of the road ahead during snowy weather. Heating elements on the lower inside windshield glass help keep wipers free from ice and the windshield clear for an unobstructed view of the road. Available.





2021 Renegade[®]
buyer's guide





Jeep® Renegade® Limited A full complement of standard comfort and convenience features sets Limited apart, beginning with a standard Uconnect® 4C NAV with a large 8.4-inch full-color touchscreen dominating the dash. Smartphone integration is assured, thanks to Apple CarPlay®¹ compatibility and Android Auto™² integration. The leather-trimmed interior offers heated front seats and steering wheel for welcome warmth on cold winter days.

LIMITED



LIMITED

STANDARD

CAPABILITY

- 1.3L 16V MultiAir®2 Turbo Direct-Injection engine with Engine Stop / Start (ESS) Technology and 9-speed automatic transmission with AutoStick
- Jeep Active Drive full-time 4x4 system with disconnecting rear axle and Power Transfer Unit (PTU)
- Selec-Terrain® Traction Management System

EXTERIOR

- SubShine grille surround and Chrome rings
- Black roof and roof rails
- Power-adjusting, heated, manual-folding exterior mirrors with turn signal in SubShine
- SubShine front and rear accents
- Bright exhaust tip
- Windshield wiper de-icer
- Rain-sensitive windshield wipers
- Cornering front fog lamps
- Automatic halogen headlamps with daytime running lamp (DRL) system
- Deep-tint sunscreen glass
- Tire Service Kit
- 215 / 60R17 BSW All-Season Touring tires

INTERIOR

- Front / rear power windows with front 1-touch up / down
- Grillz interior bezel accents
- Air conditioning with Dual-Zone Automatic Temperature Control
- 7-inch, full-color Driver Information Display
- Media Hub with USB port and auxiliary input jack; 2nd USB port located behind center console
- 115-volt and 12-volt auxiliary power outlets
- Ambient LED interior lighting
- Sun visors with illuminated mirrors
- Rearview auto-dimming mirror
- Leather-wrapped, heated steering wheel with audio and cruise controls
- Leather-wrapped shift knob
- Heated front seats

STANDARD continued

- Power 8-way driver's seat with power 4-way lumbar adjust and manual 4-way front-passenger seat
- 40 / 20 / 40 split-folding rear seats with pass-through and 3 rear-seat head restraints³²
- Front floor console with sliding armrest, cup holders, storage slot and passenger-side storage net
- 6 speakers
- Tonneau cover
- Integrated Voice Command with Bluetooth®
- Uconnect® 4C NAV with 8.4-inch touchscreen display, GPS Navigation, HD radio, Apple CarPlay³¹ compatibility and Android Auto³² integration, Bluetooth, SiriusXM® Radio⁴ (6-month trial subscription), SiriusXM Guardian³⁵ (1-year trial subscription), and SiriusXM Traffic Plus⁵ and SiriusXM Travel Link⁶ (5-year trial subscriptions)
- SiriusXM Radio⁴ (6-month trial subscription)

SAFETY & SECURITY

- 7 air bags⁸; including advanced multistage driver and front-passenger, full-length front and rear side-curtain, supplemental front-seat-mounted side, and driver's inflatable knee bolster
- All-Speed Traction Control
- Child Seat Anchor System, LATCH-ready
- ParkView® Rear Back-Up Camera⁹
- Premium tire pressure monitoring display with individual tire read-outs
- Keyless Enter 'n GoTM with push-button start
- Passive Entry / Remote Start System⁷
- Electronic Stability Control³⁰ with Electronic Roll Mitigation, Hill Start Assist and Trailer Sway Control³¹
- Antilock 4-wheel disc brakes
- Advanced Brake Assist
- Electric park brake
- Blind Spot Monitoring¹¹ and Rear Cross-Path Detection⁹ Systems
- LaneSense® Lane Departure Warning with Lane Keep Assist¹⁰
- Full-Speed Forward Collision Warning with Active Braking²
- Security alarm³³
- Remote Start System⁷

AVAILABLE

- Body-color roof

TRAILER TOW GROUP: Class III hitch receiver plus 4-pin wiring harness and full-size spare tire with matching wheel (4x4 models)

LUXURY GROUP II: Bi-function LED projector headlamps, LED taillamps, LED cornering fog lamps and LED DRLs, Auto High-Beam Headlamp Control, Adaptive Cruise Control²⁵, ParkSense® Front and Rear Park Assist System,⁴ and Parallel and Perpendicular Park and Unpark Assist System¹⁴

MOPAR® INTERIOR PREMIUM PACKAGE, BLACK: Mopar® Premium Carpet Mats and Cargo Mat in Black plus Mopar Bright Pedal Kit (requires Black interior; not available with Mopar Interior Protection Package)

MOPAR EXTERIOR APPEARANCE GROUP: Mopar Chrome Front Air Deflector, Mopar Front and Rear Splash Guards, and Mopar Side Window Deflectors

MOPAR INTERIOR PROTECTION PACKAGE: Mopar All-Weather Floor Mats, Mopar Cargo Tray and Mopar Bright Door Entry Guards (not available with Mopar Interior Premium Package)

MOPAR DECALS: Mopar Renegade® Snowboard Decal available in all exterior colors except Alpine White, and Mopar Renegade BMX Decals available in all exterior colors except Black

SUN / SOUND GROUP: Dual-pane panoramic power sunroof and Kenwood Premium Audio System with 9 speakers including subwoofer

INTERIORS

- 1) McKinley Leather trim with Ski Grey accent stitching: Black (standard)
- 2) McKinley Leather trim with tonal accent stitching: Black / Ski Grey (standard)

WHEELS

- 1) 17-inch aluminum painted Fine Silver (standard)
- 2) 19-inch polished and painted Granite Crystal (available)





Jeep® Renegade® Trailhawk® This purpose-built hill-climber is backed by the standard, Trail Rated® Jeep® Active Drive Low 4x4 System. Confidence is added with standard safety and security systems that include Blind Spot Monitoring¹¹ and Rear Cross-Path Detection⁹ Systems and LaneSense® Lane Departure Warning with Lane Keep Assist!¹⁰ The Remote Start System⁷ and Keyless Enter 'n Go™ get you going quickly, and a uniquely styled cabin boasts Ruby Red bezel accents within a spacious, configurable interior with 40/20/40 split-folding rear seats that allow you to tailor your cargo area to fit the needs of every trip.



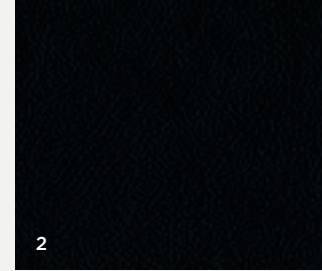
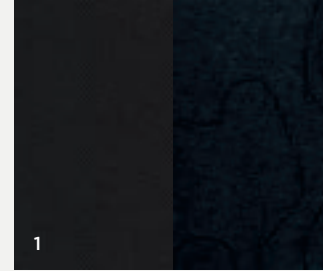

STANDARD

CAPABILITY

- 1.3L 16V MultiAir®2 Turbo Direct-Injection engine with Engine Stop / Start (ESS) Technology and 9-speed automatic transmission with AutoStick
- Jeep® Active Drive Low with disconnecting rear axle and full-time 4x4 system with low-range 21:1 crawl ratio
- Selec-Terrain® Traction Management System, including Rock mode
- Hill Descent Control
- Off-road suspension

EXTERIOR

- 0.8-inch increased fender height
- Skid plates for fuel tank, transmission, transfer case and suspension
- Front and rear Signature Ruby Red tow hooks
- Badging, side mirrors and grille rings in Neutral Gray
- Black roof and roof rails
- Unique Trailhawk® and Trail Rated® badging in Signature Ruby Red
- Hood decal in Low-Gloss Black
- Unique front and rear fascias with Black grille surround
- Rain-sensitive windshield wipers
- Power-adjusting, heated, manual-folding exterior mirrors with turn signals in Neutral Gray
- Full-size spare tire
- Automatic halogen headlamps with daytime running lamp (DRL) system
- Cornering front fog lamps
- Deep-tint sunscreen glass
- 215 / 65R17 BSW All-Season On- / Off-road tires
- Windshield wiper de-icer

INTERIOR

- Anodized Ruby Red interior bezel accents
- 7-inch, full-color Driver Information Display
- 115-volt and 12-volt auxiliary power outlets
- Leather-wrapped shift knob
- All-weather front / rear floor mats
- Air conditioning with Dual-Zone Automatic Temperature Control

STANDARD continued

- Ambient LED interior lighting
- Media Hub with USB port and auxiliary input jack; 2nd USB port located behind center console
- Sun visors with illuminated mirrors
- Leather-wrapped, heated steering wheel with audio and cruise controls
- Power 8-way driver's seat with power 4-way lumbar adjust and front-passenger manual 4-way adjust
- 40 / 20 / 40 split-folding rear seats with pass-through and 3 rear-seat head restraints²²
- Front floor console with sliding armrest, cup holders, storage slot and passenger-side storage net
- 6 speakers
- Uconnect® 4C NAV with 8.4-inch touchscreen display, GPS Navigation, HD radio, Apple CarPlay^{®1} compatibility and Android Auto^{™2} integration, Bluetooth^{®3}, SiriusXM^{®4} Radio⁴ (6-month trial subscription), SiriusXM Guardian^{™5} (1-year trial subscription), and SiriusXM Traffic Plus⁵ and SiriusXM Travel Link⁶ (5-year trial subscriptions)
- Integrated Voice Command with Bluetooth
- SiriusXM Radio⁴ (6-month trial subscription)
- Tonneau cover
- Rearview auto-dimming mirror

SAFETY & SECURITY

- 7 air bags⁸ including advanced multistage driver and front-passenger, full-length front and rear side-curtain, supplemental front-seat-mounted side, and driver's inflatable knee bolster
- All-Speed Traction Control
- Child Seat Anchor System, LATCH-ready
- Electric park brake
- Antilock 4-wheel disc brakes
- Advanced Brake Assist
- Electronic Stability Control¹⁰ with Electronic Roll Mitigation, Hill Start Assist and Trailer Sway Control¹¹
- ParkView[®] Rear Back-Up Camera⁹
- Keyless Enter 'n Go[™] with push-button start
- Premium tire pressure monitoring display with individual tire read-outs
- Blind Spot Monitoring¹³ and Rear Cross-Path Detection⁹ Systems
- LaneSense[®] Lane Departure Warning with Lane Keep Assist¹⁰
- Remote Start System⁷
- Security alarm¹⁵

AVAILABLE

TRAILER TOW GROUP: Class III hitch receiver plus 4-pin wiring harness

LUXURY GROUP III: Bi-function LED projector headlamps, LED taillamps, LED cornering fog lamps, LED DRLs and premium leather-trimmed seats

MOPAR[®] EXTERIOR APPEARANCE GROUP: Mopar[®] Chrome Front Air Deflector, Mopar Front and Rear Splash Guards, and Mopar Side Window Deflectors

SUN / SOUND GROUP: Dual-pane panoramic power sunroof and Kenwood Premium Audio System with 9 speakers including subwoofer

INTERIORS

- 1) Washington Cloth and Matric Topographic Cloth inserts with Ruby Red accent stitching and embroidered Trailhawk logo: Black (standard)
- 2) McKinley Leather trim with Ruby Red accent stitching and embroidered Trailhawk logo: Black (available)

WHEEL

- 1) 17-inch aluminum polished and painted Low-Gloss Black (standard)





Jeep® Renegade® Latitude With its deep-tint sunscreen glass, distinctive seven-slot grille, roof rails, body-color mirrors and door handles, plus bold 17-inch aluminum wheels, Latitude is ready-made to capture attention on the urban playing field. Ambient LED interior lighting, a large 7-inch Driver Information Display (DID), premium bucket cloth seats and unique Metal Diamond interior accents amp up its attitude. The available 9-speaker Kenwood Premium Audio System delivers a prime audio experience.



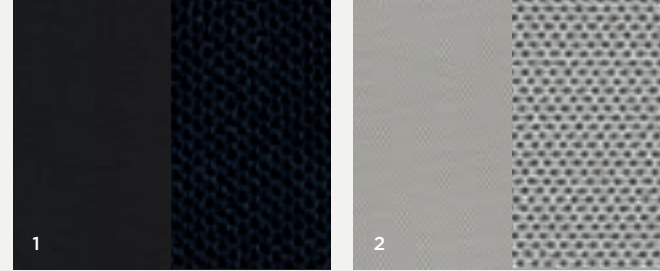

STANDARD

CAPABILITY

- 2.4L Tigershark® MultiAir®2 engine with 9-speed automatic transmission and AutoStick
- Jeep, Active Drive full-time 4x4 system (4x4 models)
- Selec-Terrain® Traction Management System (4x4 models)

EXTERIOR

- Black grille surround and Chrome rings
- Automatic halogen headlamps with daytime running lamp (DRL) system
- Cornering front fog lamps
- Black roof rails
- Power-adjusting, heated, manual-folding exterior mirrors in body-color
- Body-color door handles
- Deep-tint sunscreen glass
- Tire Service Kit
- 215/60R17 BSW All-Season Touring tires

INTERIOR

- Push-button start
- Air conditioning with Dual-Zone Automatic Temperature Control
- Metal Diamond interior bezel accents
- Ambient LED interior lighting
- Premium-wrapped steering wheel with audio and cruise controls
- 12-volt auxiliary power outlet
- 7-inch full-color Driver Information Display
- Manual 6-way driver's seat and 4-way front-passenger seat, including driver's height-adjustable seat
- 60 / 40 split-folding rear seats with 3 head restraints³²
- Front floor console with sliding armrest, cup holders, storage slot and passenger-side storage net
- Media Hub with USB port and auxiliary input jack; 2nd USB port located behind center console
- 6-speaker audio system
- Uconnect® 4 with 7-inch display, Apple CarPlay^{®1} compatibility and Android Auto^{™2} integration
- Integrated Voice Command with Bluetooth®
- SiriusXM® Radio⁴ (6-month trial subscription)

STANDARD continued

SAFETY & SECURITY

- 7 air bags⁸, including advanced multistage driver and front-passenger, full-length front and rear side-curtain, supplemental front-seat-mounted side, and driver's inflatable knee bolster
- ParkView® Rear Back-Up Camera⁹
- Electronic Stability Control³⁰ with Electronic Roll Mitigation, Hill Start Assist and Trailer Sway Control³¹
- Antilock 4-wheel disc brakes
- All-Speed Traction Control
- Child Seat Anchor System, LATCH-ready
- Advanced Brake Assist
- Premium tire pressure monitoring display with individual tire read-outs
- Blind Spot Monitoring¹¹ and Rear Cross-Path Detection⁹ Systems
- LaneSense® Lane Departure Warning with Lane Keep Assist¹⁰
- Full-Speed Forward Collision Warning with Active Braking¹²
- Security alarm³³
- SiriusXM Guardian^{™5} (1-year trial subscription)

AVAILABLE

- 1.3L MultiAir2 Turbo Direct-Injection engine with Engine Stop / Start (ESS) Technology and 9-speed automatic transmission with AutoStick
- TRAILER TOW GROUP:** Class III hitch receiver, plus 4-pin wiring harness and full-size spare tire with matching wheel (4x4 models)
- PASSIVE ENTRY / REMOTE START SYSTEM⁷ PACKAGE:** Remote Start System⁷ and Keyless Entry with panic alarm / Keyless Enter 'n Go[™]
- CONVENIENCE GROUP:** Power 8-way driver's seat with power 4-way lumbar adjust and manual 4-way front-passenger seat, 40 / 20 / 40 split-folding rear seats with pass-through, rearview auto-dimming mirror and 115-volt auxiliary power outlet, windshield wiper de-icer, all-season floor mats, heated steering wheel, tonneau cover, rain-sensitive windshield wipers and heated front seats (not available with Mopar® Interior Premium and Mopar Interior Protection Packages)

AVAILABLE continued

LUXURY GROUP 1: Bi-function LED projector headlamps, LED taillamps, LED cornering fog lamps, LED DRLs, Auto High-Beam Headlamp Control, Adaptive Cruise Control¹³, ParkSense® Front and Rear Park Assist System,¹⁴ Parallel and Perpendicular Park and Unpark Assist System,¹⁴ and Uconnect 4C NAV with 8.4-inch display (packaged with 1.3L engine)

MOPAR® INTERIOR PREMIUM PACKAGE, BLACK: Mopar Premium Carpet Mats and Cargo Mat in Black plus Mopar Bright Pedal Kit (requires Black interior; not available with Jeep 80th Anniversary Edition and Islander Edition)

MOPAR EXTERIOR APPEARANCE GROUP: Mopar Chrome Front Air Deflector, Mopar Front and Rear Splash Guards, and Mopar Side Window Deflectors (not available with Jeep 80th Anniversary Edition and Islander Edition)

MOPAR INTERIOR PROTECTION PACKAGE: Mopar All-Weather Floor Mats, Mopar Cargo Tray and Mopar Bright Door Entry Guards (not available with Jeep 80th Anniversary Edition and Islander Edition)

MOPAR DECALS: Mopar Renegade® Snowboard Decal available in all exterior colors except Alpine White, and Mopar Renegade BMX Decals available in all exterior colors except Black (not available with Jeep 80th Anniversary Edition and Islander Edition)

SUN / SOUND GROUP: Dual-pane panoramic power sunroof and Kenwood Premium Audio System with 9 speakers including subwoofer

ISLANDER EDITION: Unique Islander hood decal, Remote Start System⁷, power-adjusting, heated, manual-folding exterior mirrors with turn signals in Bright, dual-pane panoramic power sunroof, Keyless Enter 'n Go, 19-inch painted Silver wheels with 235 / 45R19 BSW All-Season tires and premium cloth low-back bucket seats in Black; available in Bikini Metallic, Omaha Orange, Glacier Metallic and Jetset Blue exterior colors (not available with Sun / Sound Group)

INTERIORS

- 1) Washington Cloth and Cappellini-embossed Cloth with tonal accent stitching; Black (standard)
- 2) Washington Cloth and Cappellini-embossed Cloth with Iced Blue accent stitching; Black / Ski Grey (standard)

WHEELS

- 1) 17-inch aluminum painted Fine Silver (standard)
- 2) 19-inch polished and painted Granite Crystal (limited availability)





Jeep® Renegade® Sport Here's where you'll start having more fun out in the world. Renegade® Sport opens the door to Jeep® Brand capability, handing over all the confidence to go where others only dream of reaching. You'll be backed up with more standard safety features than ever before, including Blind Spot Monitoring¹¹ and Rear Cross-Path Detection⁹ Systems, Full-Speed Forward Collision Warning with Active Braking;¹² and LaneSense® Lane Departure Warning with Lane Keep Assist!¹⁰

SPORT



SPORT

STANDARD

CAPABILITY

- 2.4L Tigershark® MultiAir® 2 I-4 engine with 9-speed automatic transmission and AutoStick
- Jeep, Active Drive full-time 4x4 system with disconnecting rear axle and Power Transfer Unit (PTU) (4x4 models)
- Selec-Terrain® Traction Management System (4x4 models)

EXTERIOR

- Black grille surround and Chrome rings
- Power-adjusting, heated, manual-folding exterior mirrors in Black
- Black door handles
- Halogen headlamps with daytime running lamp (DRL) system
- Front / rear power windows with front 1-touch up / down
- 215 / 65R16 All-Season tires
- Tire Service Kit

INTERIOR

- Cruise control
- Push-button start
- Air conditioning with Dual-Zone Automatic Temperature Control
- Metal Diamond interior bezel accents
- 3.5-inch monochrome Driver Information Display
- Media Hub with USB port and auxiliary input jack
- 12-volt auxiliary power outlet
- Urethane steering wheel with audio and cruise controls
- Speed-sensitive power door locks
- Manual 6-way driver's seat and 4-way front-passenger seat, including driver's height-adjustable seat
- Fold-forward front-passenger seat
- 60 / 40 split-folding rear seats with 3 head restraints³²
- Front floor console with sliding armrest and cup holders, storage slot and passenger-side storage net
- Carpeted front / rear floor mats
- Height-adjustable cargo load floor
- Urethane shift knob
- Driver and front-passenger sun visors with mirror
- Driver and passenger assist handles
- Locking glove box with lamp
- Cargo tie-down loops
- 6-speaker audio system
- Uconnect® 4 with 7-inch touchscreen display, Apple CarPlay³¹ compatibility and Android Auto³² integration

STANDARD continued

- Integrated Voice Command with Bluetooth® for hands-free¹⁶ communication
- SiriusXM® Radio⁴ (6-month trial subscription)
- SiriusXM Guardian^{TM5} (1-year trial subscription)

SAFETY & SECURITY

- 7 air bags,⁸ including advanced multistage driver and front-passenger, full-length front and rear side-curtain, supplemental front-seat-mounted side, and driver's inflatable knee bolster
- All-Speed Traction Control
- Electronic Stability Control³⁰ with Electronic Roll Mitigation, Hill Start Assist and Trailer Sway Control³¹
- Antilock 4-wheel disc brakes
- Electric park brake
- Premium tire pressure monitoring display with individual tire read-outs
- Advanced Brake Assist
- ParkView® Rear Back-Up Camera³
- Child Seat Anchor System, LATCH-ready
- Center rear 3-point seat belt
- Battery-rundown protection
- Blind Spot Monitoring¹¹ and Rear Cross-Path Detection⁹ Systems
- LaneSense® Lane Departure Warning with Lane Keep Assist¹⁰
- Full-Speed Forward Collision Warning with Active Braking¹²

AVAILABLE

SPORT APPEARANCE GROUP: Black side roof rails, deep-tint sunscreen glass, 17-inch aluminum painted Fine Silver wheels and 215 / 60R17 BSW All-Season Touring tires (not available with Freedom and Jeepster Editions)

MOPAR® INTERIOR PREMIUM PACKAGE, BLACK: Mopar® Premium Carpet Mats and Cargo Mat in Black plus Mopar Bright Pedal Kit (not available with Mopar Interior Protection Package)

MOPAR EXTERIOR APPEARANCE GROUP: Mopar Chrome Front Air Deflector, Mopar Front and Rear Splash Guards, and Mopar Side Window Deflectors

MOPAR INTERIOR PROTECTION PACKAGE: Mopar All-Weather Floor Mats, Mopar Cargo Tray and Mopar Bright Door Entry Guards (not available with Mopar Interior Premium Package)

AVAILABLE continued

MOPAR DECALS: Mopar Renegade® Snowboard Decal available in all exterior colors except Alpine White, and Mopar Renegade BMX Decals available in all exterior colors except Black

JEEPSTER EDITION: Unique Jeepster decals, Passive Entry/Keyless Enter 'n Go, Remote Start System⁷, deep-tint sunscreen glass, Black cloth seats with Ski Grey accent stitching and 19-inch polished and painted aluminum wheels with 235 / 45R19 BSW All-Season tires; available in Colorado Red, Black and exclusive Technogreen Metallic and Mojave Sand exterior colors

FREEDOM EDITION: On 4x4 models, unique Oscar Mike hood decal, American flag decals, body-color door handles, Black side roof rails, Gloss Black exterior accents and badging, Trailhawk® front fascia with 2 front tow hooks in Black, front suspension skid plate, deep-tint sunscreen glass, cornering front fog lamps with Gloss Black bezels, Black grille with Gloss Black rings, 17-inch Matte Black aluminum wheels, premium cloth bucket seats in Black with Tungsten accent stitching and "Oscar Mike" embroidered on the front row seatbacks, all-season floor mats and Keyless Enter 'n GoTM; available in Slate Blue Pearl, Alpine White, Black and Sting-Gray exterior colors (not available with Sport Appearance Group)

INTERIOR

- 1) Washington Cloth and Mesh Cloth with tonal accent stitching: Black (standard)

WHEELS

- 1) 16-inch styled Black steel (standard)
- 2) 17-inch aluminum painted Fine Silver (available)



2021 Renegade® Special Edition

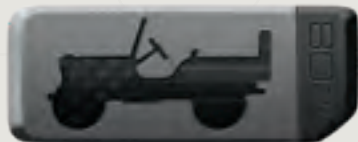

INTERIOR

1) Washington Cloth and Strata-embossed Cloth inserts with Light Tungsten accent stitching and 80th Edition seat tag – Black



WHEEL

1) 19-inch Granite-painted aluminum



Jeep® 80th Anniversary Edition

Includes Latitude content plus:

- 19-inch Granite-Painted Aluminum Wheels
- Uconnect® 4C NAV with 8.4-inch Touchscreen Display
- Commemorative Jeep® 80th Anniversary Edition Badge
- Satin Granite Exterior Accents
- Granite Crystal Jeep Badge and Grille Rings
- Satin Granite Roof Rails
- Commemorative Jeep 80th Anniversary Edition Black Premium Cloth Seats with 80th Edition Seat Tags on Front Seats
- Black Headliner
- Berber Floor Mats with 80th Anniversary Tag
- Commemorative Jeep 80th Anniversary Badge on Instrument Panel
- Gloss Black Steering-Wheel Bezels
- Anodized Gunmetal Speaker and Outer Vent Bezels
- Available in All Exterior Colors except Sting-Gray and Glacier Metallic
- Available Luxury Group II includes Bi-function LED Projector Headlamps, LED Taillamps, LED Cornering Fog Lamps, LED Daytime Running Lamps (DRLs), Auto High-Beam Headlamp Control, Adaptive Cruise Control,¹³ ParkSense® Front and Rear Park Assist System,¹⁴ and Parallel and Perpendicular Park and Unpark Assist System¹⁴ (requires 1.3L engine)

SPECIFICATIONS

EXTERIOR DIMENSIONS (inches unless otherwise noted)

Wheelbase	101.2
Overall Length	166.6
Overall Width (with open side mirrors)	79.6
Track (front / rear)	60.6 / 60.6
Overall Height	66.5

	4x2 / 4x4 / Trailhawk®
Ground Clearance	6.7 / 8.0 / 8.7
Approach Angle (deg)	17.9 / 21.0 / 30.5
Breakover Angle (deg)	21.2 / 24.0 / 25.7
Departure Angle (deg)	29.7 / 32.1 / 34.3
Water Forging Depth ²⁸	N/A / 12.0 / 19.0

INTERIOR DIMENSIONS (inches unless otherwise noted)

	Front / Rear
Seating Capacity	2 / 3 adults
Head Room (without sunroof)	41.1 / 40.5
Head Room (with sunroof)	39.7 / 40.5
Leg Room	41.2 / 35.1
Shoulder Room	55.9 / 55.1
Hip Room	53.1 / 51.9
SAE Cargo Volume (cu ft): rear seat up	18.5
rear seat folded	50.8
EPA Interior Volume Index (cu ft)	118.6

BRAKE SYSTEM — Antilock Brake System (ABS)

Front: 12 x 1.1-in vented rotor with 2.36-in single-piston floating caliper
Rear: 10.95 x 0.47-in solid rotor with 1.5-in single-piston floating caliper

BODY DESIGN — Unibody construction: upper body and frame members welded and bonded into a single unit

SUSPENSION — Front: MacPherson struts, coil springs, flat-front steel crossmember, high-strength steel double-shell lower control arms for 4x4 and high-strength steel mono-shell lower control arms for 4x2 and stabilizer bar. Rear: Chapman struts, high-strength steel links, isolated steel rear cradle for 4x4 and not-isolated for 4x2, coil springs and stabilizer bar

STEERING — Electric power rack and pinion

Overall ratio	15.7:1
Turns (lock-to-lock): 4x2 and 4x4	2.68
Trailhawk	2.76

Turning diameter (curb-to-curb; ft):

4x2 and 4x4	36.3
Trailhawk	35.3

CAPACITIES / WEIGHTS (pounds unless otherwise noted)

Fuel Tank (gal)	12.7
Base Curb Weight	
1.3L 4x2	3,161
1.3L 4x4	3,320
2.4L 4x2	3,159
2.4L 4x4	3,323
1.3L 4x4 Trailhawk	3,527
Towing Capacity (when properly equipped; 4x4 models only)	2,000

POWERTRAINS

Engine	1.3L MultiAir®2 Turbo I-4	2.4L Tigershark® MultiAir2
Displacement (cc)	1,332	2,360
Horsepower (SAE @ rpm)	177 @ 5,750	180 @ 6,400
Torque (SAE net lb-ft @ rpm)	210 @ 1,750	175 @ 3,900
Axle Ratio	4.585 (Trailhawk)	3.734 (Sport and Latitude)
Fuel Injection System	Direct injection	Sequential, multiport, electronic, returnless
2021 EPA-Estimated Highway MPG	32 ²⁹	30 ³⁴



exterior colors

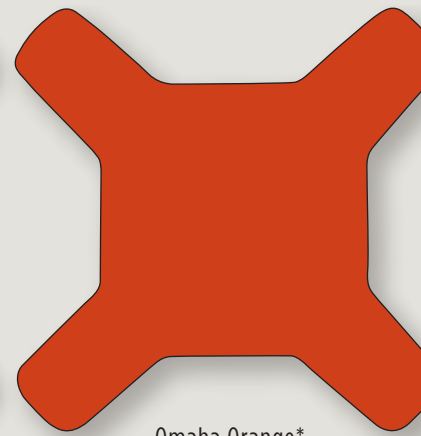
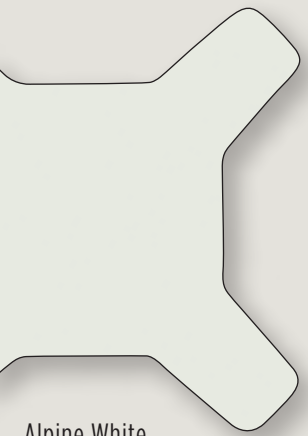

Alpine White

Sting-Gray

Jetset Blue

Granite Crystal Metallic

Omaha Orange*

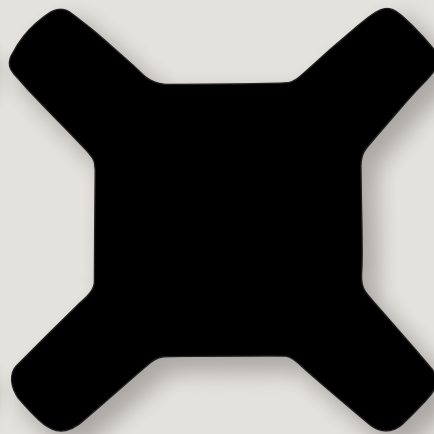
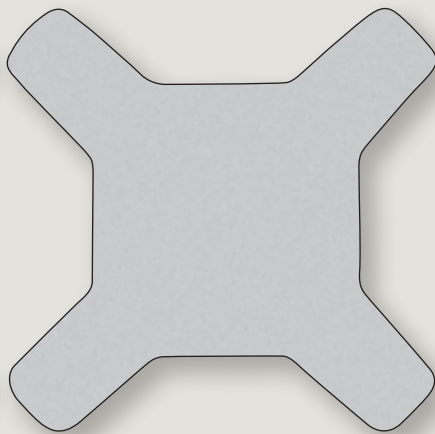
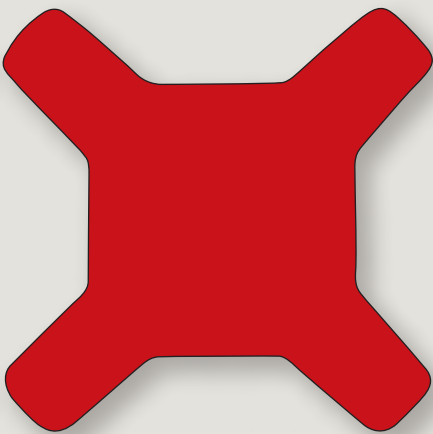
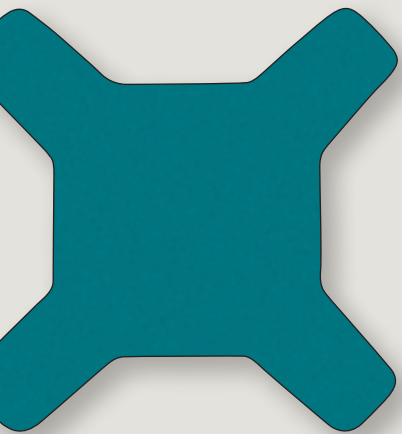

Bikini Metallic

Colorado Red

Glacier Metallic

Black

Slate Blue Pearl

*Exterior color availability may vary by trim.



AUTHENTIC JEEP® BRAND VEHICLE ACCESSORIES

When it comes to your Jeep® Renegade®, not all parts and accessories are created equal. As the official service, parts and customer care provider for the Jeep Brand, only Mopar® Parts and Accessories can ensure the proper fit, finish and functionality. That's because they're original equipment, engineered by the same people who designed your vehicle, which means you can personalize your ride with complete confidence.

Mopar is also more than parts and accessories. We're here to help you properly maintain and care for your vehicle. Our certified technicians are trained to know your vehicle best, and our Mopar Express Lane service departments are set up to get you in, out and back on the road. From parts and accessories to expert service and more, always be sure to choose Mopar. Learn more at mopar.com



Vehicle above shown with Authentic Jeep® Brand Vehicle Accessories by Mopar®, including Roof Rack Crossrails, Ski and Snowboard Carrier, and Rock Rails. Properly secure all cargo.



Cargo Tote



Rock Rails



Molded Cargo Tray

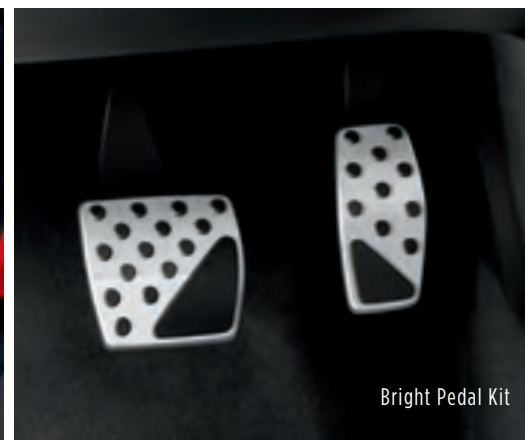

Bright Pedal Kit



EXCLUSIVE BENEFITS FOR EVERY JEEP® RENEGADE® OWNER

All 2021 Jeep® Renegade® vehicles are automatically enrolled in the Jeep Wave® Customer Care Program. It's a program designed to provide Jeep Brand vehicle owners with dedicated 24/7 owner support and a special package of benefits designed to enhance their ownership experience and thank them for their patronage. Visit [JEEP.COM/WAVE](https://www.jeep.com/wave) for more details.



NO ADDITIONAL CHARGE
WORRY-FREE MAINTENANCE



CONFIDENCE WITH VEHICLE PROTECTION



DEDICATED 24/7 OWNER SUPPORT



VIP ACCESS TO JEEP BRAND EVENTS



NO-CHARGE SAME-DAY RENTAL COVERAGE



OWNER SUPPORT

THE JEEP® BRAND
IS PROUD TO OFFER SOME
OF THE BEST OWNERSHIP
SUPPORT PROGRAMS
AVAILABLE ANYWHERE.



5 YEAR / 60,000 MILE
POWERTRAIN LIMITED WARRANTY

WARRANTIES Jeep® Brand vehicles are covered by a 3-Year / 36,000-Mile Basic Limited Warranty³⁵ (excludes normal maintenance and wear items), as well as a 5-Year / 60,000-Mile Powertrain Limited Warranty³⁶ that is fully transferable. See your dealer for complete details and a copy of the 5-Year / 60,000-Mile Powertrain Limited Warranty³⁶.



VEHICLE PROTECTION

MOPAR® VEHICLE PROTECTION PLANS A variety of Protection Plans accepted at all FCA US LLC dealerships have been designed to meet the needs of your unique lifestyle on the road. We stand behind every extended protection plan with certified, factory-trained technicians and the use of original equipment parts. Ask for a Mopar® Vehicle Protection Plan at your dealership, call (800) 442-2666 or visit mopar.com



DRIVEABILITY | FCA

DRIVEABILITY PROGRAM The FCA US LLC DriveAbility Program provides aftermarket reimbursement incentives on adaptive vehicle upfit equipment to help provide safe and reliable vehicle modifications, enhancing accessibility for all people. For more information, call (800) 255-9877 or visit fcausdriveability.com

MOPAR® OWNER'S SITE & COMPANION APP Get all of the resources you need to make owning your Jeep® Brand vehicle the best experience possible. Schedule service directly with your preferred dealer, create a custom online dashboard tailored to you and your vehicle, and access personalized resources, including your Owner's Manual, Vehicle Health Report, special offers and more — anytime, anywhere. Register your vehicle at mopar.com or download the Mopar® Owner's Companion App today.

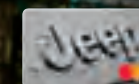

JEOP DRIVEPLUSSM MASTERCARD[®]
Apply today for a Jeep® DrivePlusSM Mastercard[®] and, upon approval, start earning 5% back on Jeep

dealership purchases, 2% back on gas and travel purchases, and 1% back on purchases everywhere else.³⁷ Redeem your rewards toward your next service or your next Jeep purchase. Go to drivepluscard.com or visit a participating dealer to learn more.

JEEP® LIFE

EXPANDED HORIZONS

DELVE DEEPER INTO THE JEEP® LIFE WITH AN EXPANSIVE ARRAY OF SOCIAL MEDIA, SHOPPING, OWNER RESOURCES AND ONE-OF-A-KIND EVENTS. START YOUR ADVENTURE TODAY AT JEEP.COM

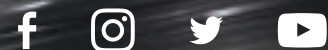

Jeep Gear

SOCIAL ADVENTURES Expand your horizons to include authentic and active Jeep® Brand online communities. Post stories, share photos, watch videos and get the latest news from Jeep Brand gearheads and engineers on Facebook, Instagram, Twitter and YouTube. Tune in and get out into the virtual world, where thrilling adventures are happening every single day.

facebook.com/Jeep

instagram.com/Jeepofficial

twitter.com/Jeep

youtube.com/TheJeepChannel

JEEP® BADGE OF HONOR Experience an online community that invites off-road fans to sign up, download the app and check in to legendary off-road trails across the U.S. — earmarked by the Jeep® Badge of Honor. Members can discover special trails and maps, earn Trail Points and ranks within the community, share photos and learn more about Jeep Trail Ratings. Connect with fellow Jeep Brand vehicle owners and like-minded friends at jeep.com/badge-of-honor

JEEP® GEAR Uncover an extensive line of fun, developed exclusively for Jeep® Brand enthusiasts. From authentic wearables to unique gifts, all items are as rugged and durable as your Jeep Brand vehicle. Express your true nature. Learn more at jeep.com/gear





AN UNSTOPPABLE PEDIGREE

NO OTHER AUTOMOTIVE BRAND ON EARTH OWNS 4x4 INNOVATION LIKE THE JEEP® BRAND. FROM THE INDISPENSABLE WILLYS MB DURING WWII TO THE UNDENIABLE ORIGINALITY OF THE NEW GLADIATOR TRUCK, JEEP VEHICLES HAVE CONSISTENTLY BROUGHT FIRSTS TO THE FOUR-WHEEL-DRIVE (4WD) SEGMENT, TAKING ADVENTURE-SEEKERS TO PLACES OTHERS ONLY DREAM OF REACHING. OUR PROMISE TO CONTINUALLY OFFER LEGENDARY CAPABILITY, OPEN-AIR FREEDOM, STYLE, 4xe HYBRIDS, SAFETY AND TECHNOLOGY REMAINS EVER AT OUR FOREFRONT.



CELEBRATING YEARS OF THE JEEP BRAND

(1) Requires compatible iPhone. See dealer for phone compatibility. Data plan rates apply. Vehicle user interface is a product of Apple. Apple CarPlay is a trademark of Apple Inc. iPhone is a trademark of Apple Inc., registered in the US and other countries. Apple terms of use and privacy statements apply. (2) To use Android Auto on your phone screen, you'll need an Android phone running 5.0 or higher and the Android Auto App. Google, Android, Android Auto, YouTube and other related marks and logos are trademarks of Google LLC. (3) Requires an iPhone with Siri. Certain features are not available while the vehicle is in motion. iPhone must be within active cellular range. Customer's existing iPhone data rates apply to Internet-supported features. (4) Your service will automatically stop at the end of your trial subscription unless you decide to continue service. If you do not wish to enjoy your trial subscription, you can cancel it by calling the number below. If you decide to continue service after your trial subscription, the subscription plan you choose will automatically renew thereafter and you will be charged according to your chosen payment method at then-current rates. Fees and taxes apply. Please see our Customer Agreement at www.siriusxm.com for complete terms and how to cancel, which includes calling us at 1-866-635-2349. All fees, content and features are subject to change. (5) All SiriusXM Guardian equipped vehicles come with a 12-month complimentary trial effective on the date of purchase or lease of a new vehicle. Enrollment in the trial is required to receive service. Upon expiration of the trial period, purchase of a subscription is required to continue SiriusXM Guardian. SiriusXM Guardian is available only on equipped vehicles purchased within the United States and Puerto Rico. Services can only be used where cellular coverage is available. See Uconnect and SiriusXM Guardian Terms of Service for complete service limitations. (6) Not all vehicles or devices are capable of receiving all services offered by SiriusXM. Data displays and individual product availability vary by vehicle hardware. Current information and features may not be available in all locations, or on all receivers. Weather Forecast. Current Conditions may not be available in all locations. (7) Check state and local laws regarding the use of remote start systems. (8) Always sit properly in designated seating positions with seat belts securely fastened at all times. (9) Always check entire surroundings visually before proceeding. (10) This system is a driver convenience system, not a substitute for active driver involvement. The driver must remain aware of traffic conditions and maintain control of the vehicle. (11) Always check visually for vehicles prior to changing lanes. (12) This system is solely an alert system for the front of the vehicle that does not take any actions to change vehicle dynamics to avoid a collision, not a substitute for active driver involvement. The driver must remain aware of traffic conditions and be prepared to use the brakes to avoid collisions. (13) This system is a driver convenience system, not a substitute for active driver involvement. The driver must remain aware of traffic conditions and be prepared to use the brakes to avoid collisions. (14) Always look before proceeding. An electronic drive aid is not a substitute for conscientious driving. Always be aware of your surroundings. (15) You are responsible for using remote features in accordance with any laws, rules or ordinances in effect in your vehicle's location. You must have an active subscription to SiriusXM Guardian in order to use remote services. See Terms of Service for service limitations. (16) The Uconnect Phone requires a mobile phone equipped with the Bluetooth Hands-Free Profile. To check phone compatibility, please visit www.UconnectPhone.com. (17) Voice Text Reply feature requires a compatible mobile device that supports text messaging and Bluetooth. Visit www.UconnectPhone.com for system and device compatibility. (18) Three-month/1GB trial included with the purchase or lease of a new vehicle. Upon expiration of the trial period, purchase of a subscription is required. Wi-Fi Hotspot available through third-party subscription. Requires Internet-enabled mobile device. See dealer for details. This feature is not intended for use by the driver while the vehicle is in motion. Always drive carefully. (19) In the event of a medical or other emergency, press the SOS button to be connected to a Customer Care agent who can direct emergency assistance to your vehicle's location. (20) Roadside Assistance Call connects you with an agent who will provide Roadside Assistance Service. Vehicle must be within the United States, Puerto Rico or Canada and have network coverage. Additional roadside assistance charges may apply. Check warranty for details. (21) Remote Vehicle Start is not available on all vehicles. You are responsible for using remote features in accordance with any laws, rules or ordinances in effect in your vehicle's location. (22) To use Vehicle Finder, you must have the Uconnect App with SiriusXM Guardian installed on a compatible smartphone and have an active subscription to SiriusXM Guardian. (23) Send & Go requires a vehicle equipped with Navigation. To use Send & Go, you must have the Uconnect App with SiriusXM Guardian installed on a compatible smartphone and have an active subscription to SiriusXM Guardian. (24) Theft Alarm Notification is compatible with factory-installed alarms only. (25) Stolen vehicle police report required. (26) Available only on equipped vehicles with an active subscription to SiriusXM Guardian connected services (Family Drive Alerts is not available on vehicles with 12-inch touchscreen). All SiriusXM Guardian equipped vehicles come with a 12-month trial of the full suite of services effective on the date of purchase or lease of a new vehicle. Enrollment in the trial is required to receive service. Upon expiration of the trial period, purchase of a subscription is required to continue services. Services can only be used within the United States and Puerto Rico where cellular coverage is available. See coverage map for details. (27) Compatible with properly equipped Uconnect systems on eligible vehicles. Requires registration of vehicle to SiriusXM Guardian connected services and fulfillment of minimum subscription requirements. Late availability. Amazon, Alexa and all related logos and marks are trademarks of Amazon.com, Inc. or its affiliates. (28) Do not attempt water fording unless depth is known and consistent with the vehicle's water fording rating in the Owner's Manual. Traversing water can cause damage that may not be covered by the new vehicle warranty. Always off-road responsibly in approved areas. (29) Based on 2021 EPA-estimated 24 city/32 hwy mpg when equipped with 1.4L engine and 9-speed automatic transmission, FWD. Actual mileage may vary. (30) Always drive carefully, consistent with conditions. Always wear your seat belt and obey traffic laws. (31) Always drive carefully, consistent with conditions. (32) Always sit properly with the head restraint properly adjusted. Never place anything in front of the head restraint. (33) Vehicle must be locked and system activated for alarm to sound. (34) Based on 2021 EPA-estimated 22 city/30 hwy mpg when equipped with 2.4L engine and 9-speed automatic transmission, FWD. Actual mileage may vary. (35) Visit Mopar.com for complete details and a copy of the Basic Limited Warranty. (36) Visit Mopar.com for complete details and a copy of the Powertrain Limited Warranty. (37) See the Reward Terms and Conditions in the Summary of Credit Terms provided at time of application for details, including earning, redemption, expiration or forfeiture. Percentage back is earned as points.

©2020 FCA US LLC. All Rights Reserved. Jeep, Mopar, Badge of Honor, DrivePlus, the DrivePlus design, Go Anywhere, Do Anything, the Jeep grille, Jeep Wave, the Jeep Wave Equipped design, LaneSense, Latitude, Limited, Mopar Vehicle Protection, ParkSense, ParkView, Renegade, Selec-Terrain, Tigershark, Trailhawk, Trail Rated, the Trail Rated 4x4 design and Uconnect are registered trademarks and DriveAbility and the DriveAbility design, Jeep Active Drive, Jeep Active Drive Low, Keyless Enter™ Go and Send & Go are trademarks of FCA US LLC.

MultiAir is a registered trademark of C.R.F. Società Consortile per Azioni, used under license by FCA US LLC. Amazon, Alexa and all related logos and marks are trademarks of Amazon.com, Inc. or its affiliates. Apple, Apple Music, Apple Watch, iPhone, iTunes and Siri are registered trademarks and Apple CarPlay is a trademark of Apple Inc. Bluetooth is a registered trademark of Bluetooth SIG, Inc. Facebook and logo are registered trademarks of Facebook, Inc. Google, Android, Google Play, Android Auto and other related marks and logos are trademarks of Google LLC. Instagram is a registered trademark of Instagram, Inc. KENWOOD is a registered trademark of JVC KENWOOD Corporation. Mastercard Cards are issued by First Bankcard, a division of First National Bank of Omaha pursuant to a license from Mastercard International Incorporated. Mastercard is a registered trademark and the circles design is a trademark of Mastercard International Incorporated. SiriusXM Connected Vehicles Services Inc., Sirius, XM, SiriusXM, SiriusXM Guardian and all related marks and logos are registered trademarks of SiriusXM Radio Inc. The Twitter name, logo, Twitter f, Tweet and Twitter bird are service marks of Twitter, Inc. in the United States and other countries.

This brochure is a publication of FCA US LLC. All product illustrations and specifications are based upon current competitive information at the time of publication approval. FCA US LLC reserves the right to make changes from time to time, without notice or obligation, in prices, specifications, colors and materials, and to change or discontinue models which are considered necessary to the purpose of product improvement or for reasons of design and/or marketing.

JEEP.COM

Jeep is a registered trademark of FCA US LLC.

Jeep

THERE'S ONLY ONE

(800) 925-JEEP

74-383-2105