

2019 F-150



XL | XLT | LARIAT | KING RANCH® | PLATINUM | LIMITED | RAPTOR



THERE'S NO TOUGH LIKE BUILT FORD TOUGH

It's more than just a brutal testing regimen. Built Ford Tough® is a battle cry. One filled with honor, courage and determination to never rest – until the job's done right. With well over 10 million customer-equivalent miles of testing, F-150 earned its Blue Oval. Being tortured in the lab. On the proving grounds. And working in the real world. Have no doubt, this truck is engineered for the long haul. Having repeatedly passed our toughest tests, it's more than ready for yours.

Settle into any 2019 F-150 – from the easy-to-clean vinyl seats¹ of the XL work truck to the new RECARO® sport seats¹ of RAPTOR – and you'll find a truck that embraces hard work as just another day at the office. F-150 is part of the legendary F-Series lineup that's been America's best-selling truck for 41 years. And with more trucks on the road with 250,000 miles than any other brand, there's nothing tougher than Ford F-Series²



2019 F-150 | ford.com

XLT SuperCrew® 4x4. Agate Black. FX4 Off-Road Package. Available equipment. ¹Available feature. ²"More trucks on the road" based on IHS Markit Vehicles in Operation (VIO) data and latest odometer readings available to IHS Markit for 1992 and newer model year full-size pickups still on the road in the U.S. as of 4/1/2018.

Try to avoid water higher than the bottom of the hubs and proceed slowly. Refer to your owner's manual for detailed information regarding driving through water.





GREAT STRENGTH. LESS WEIGHT. The high-strength, military-grade, aluminum alloy¹ of the F-150 body and cargo box is hardened through heat treating to produce greater strength. Gauge (or thickness) is also increased where needed to achieve extra strength without increasing weight. Today's F-150 now achieves best-in-class² max. ratings for: overall towing,³ overall payload³ and an available diesel EPA-estimated fuel economy rating of 30 mpg hwy.⁴ That's leadership that counts. All day long.

RESISTS CORROSION. WON'T RUST. Another amazing benefit of high-strength, military-grade, aluminum alloy. But what about the F-150 frame? The entire high-strength-steel frame is immersed in an e-coat solution while an electric charge is applied. This forms a durable protective shell that bonds with the steel to help inhibit rust, even in hidden areas.

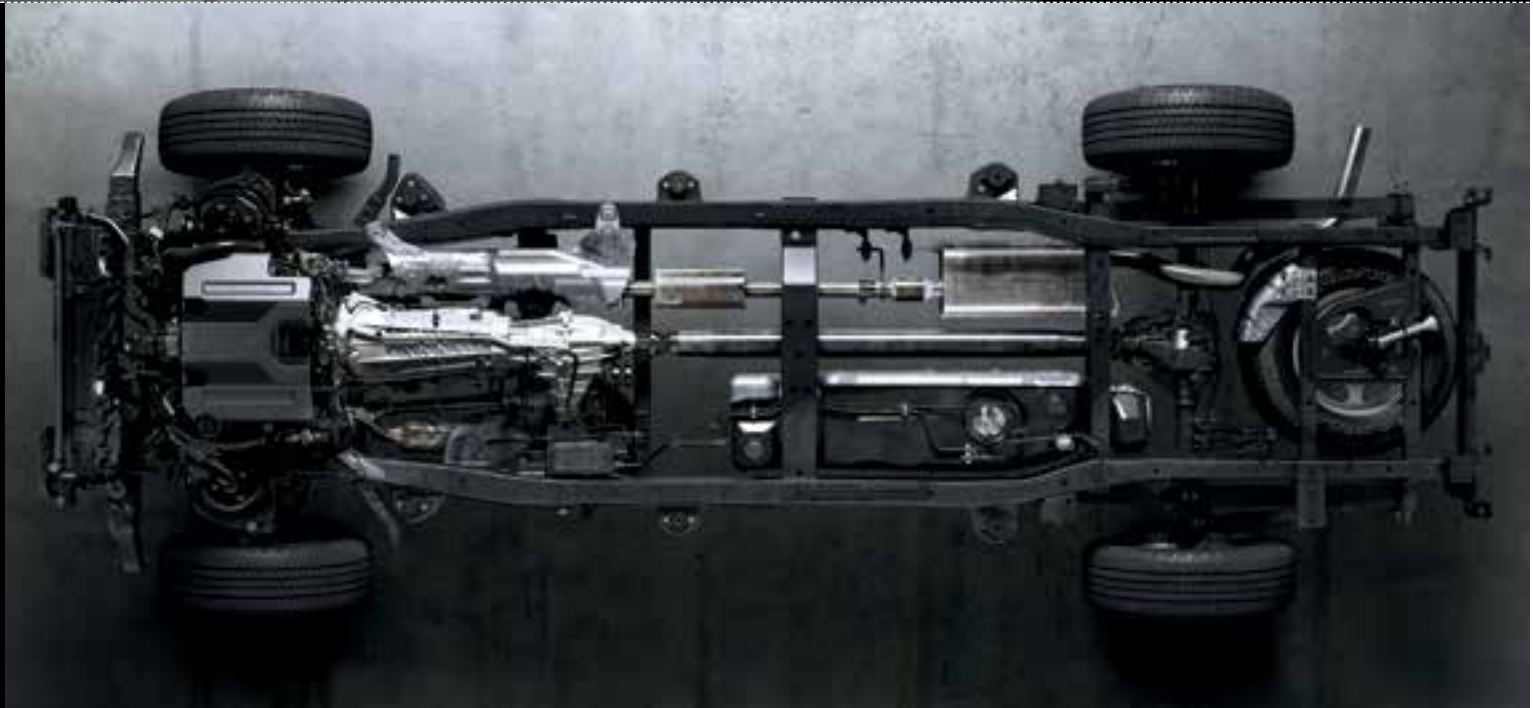

THE STRONGEST FRAME EVER CREATED for F-150 is a fully boxed, modular foundation comprised of 78% high-strength steel. This highly rigid structure enhances stiffness and durability.

8 RUGGED CROSSMEMBERS (5 are through-welded) and large cross-section frame rails form the perfect foundation for our revolutionary truck body and cargo box.



To help reduce crush into the passenger compartment in certain front, side and rear impacts, a masterful mix of high-strength, military-grade aluminum alloys works together with a unique high-strength-steel frame structure. A patented 12-sided design in the high-strength-steel front frame horn improves front-impact protection, compared to a traditional rectangular design, by helping to dissipate crash energy. Additional through-welded crossmembers bolster side-impact protection.

FIRST-IN-CLASS INFLATABLE REAR SAFETY BELTS¹ for outboard passengers join 6 standard airbags to enhance occupant protection. To reduce injury risk in certain collisions, the fully inflated safety belt distributes crash energy across 5 times more of an occupant's body than a non-inflatable safety belt.



“FX4 Off Road” decals on your pickup box let everyone know your F-150 is capable of serious, off-road travel. The FX4 Off-Road Package equips your truck to get out there with an electronic-locking rear differential, underbody skid plates that help protect the front differential, transfer case and fuel tank, Hill Descent Control,[™] and off-road-tuned shock absorbers. Monitor the action from the driver's seat on the off-road display in the productivity screen.

○ XL, XLT, LARIAT, KING RANCH,® PLATINUM



NAVIGATE TIGHT SPOTS ON THE TRAIL by utilizing Ford Co-Pilot360[™] Technology such as our 360-Degree Camera with Split-View Display.² Four cameras give you a bird's-eye view, helping you maneuver down narrow trails. To keep your view clear of dust and mud, the forward-facing camera includes a lens washer that's activated whenever the windshield washers are used.

● LIMITED
○ LARIAT, KING RANCH, PLATINUM, RAPTOR
● STANDARD ○ AVAILABLE

EVERY OTHER TRUCK: STILL PLAYING CATCH-UP TO FORD F-150

It won't be any easier this year. The High-Output 3.5L EcoBoost® engine that produces a best-in-class 510 lb.-ft. of torque¹ is now standard on two 2019 F-150 models: the Baja-bred RAPTOR and luxurious LIMITED. With the addition of blistering performance to its truckload of amenities, the new F-150 LIMITED redefines what a luxury pickup truck can be. Again.

And RAPTOR? Its already otherworldly reputation is improved with enhanced off-road capability. The 2019 RAPTOR offers a new Trail Control™ system for off-road terrain, which allows you to set the speed from 1 to 20 mph (depending on transfer case setting). The Trail Control feature manages acceleration and braking so you can concentrate on steering. Plus, new FOX Racing Shox™ 3.0 internal bypass shock absorbers feature all-new, electronically controlled Live Valve technology that automatically adjusts compression damping based on the terrain and how aggressively you attack it. A RAPTOR that's even more off-road capable? You better believe it. Around here, the throttle stays pegged.



PACK QUITE A PUNCH

With one of 5 advanced F-150 gas engines, including the 450-hp¹ High-Output 3.5L EcoBoost® engine standard on RAPTOR and LIMITED. Or, with the newest addition to the lineup: a torque-heavy 3.0L diesel engine² bearing the legendary Power Stroke® name. That's 6 powerful choices in an engine lineup that truly has something for everyone.

Equally noteworthy: all F-150 engines benefit from standard Auto Start-Stop Technology that helps to reduce fuel consumption and vehicle emissions during city driving. Tuned specifically for rigorous truck applications, Auto Start-Stop will not intervene when F-150 is in tow/haul mode, 4-wheel drive (4WD) and other circumstances that require the engine to drive essential accessories. For ease of use and convenience, all engines are teamed with automatic transmissions featuring SelectShift® capability.



CLASS-BEST
510 LB.-FT. TORQUE¹

CLASS-BEST
450 HORSE POWER¹

450 HP OF FLAT-OUT LUXURY. The unique satin finish on the grille, door handles, tailgate appliqué and dual exhaust tips of the 2019 F-150 LIMITED will certainly catch your eye. As will the massive 22" polished-aluminum wheels. What you'll appreciate most, however, is the immediate responsiveness of the High-Output 3.5L EcoBoost engine every time you press the accelerator. Catch one if you can.

ENGINES

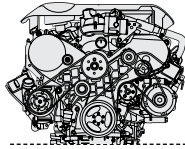

3.3L Ti-VCT V6

Equipped with the standard powerplant, F-150 supplies plenty of working power to tow and haul. That's a clean sweep in any truck buyer's ledger. "Even the base 3.3L V6 had zero trouble hauling a 5,000-pound trailer," says *Motor Trend*.

A dual-injection system features both direct injection and port fuel injection. Two injectors per cylinder – one mounted in the intake port and another inside the cylinder – improve power output and efficiency. A 6-speed automatic transmission with SelectShift® capability is paired with the 3.3L Ti-VCT V6 engine.

Horsepower	290 @ 6,500 rpm
Torque	265 lb.-ft. @ 4,000 rpm
Max. payload capacity ³	1,990 lbs.
Max. towing capacity ³	7,700 lbs.
EPA-estimated ratings ⁴	(4x2) 19 mpg city/25 mpg hwy/22 mpg combined (4x4) 18 mpg city/23 mpg hwy/20 mpg combined
Induction system	Naturally aspirated
Transmission	6-speed SelectShift automatic

○ AVAILABLE ○ XL, XLT

2.7L ECOBOOST

To understand an engine's specific output, divide its horsepower by its displacement. At a staggering 120 hp/L, you'll know why the 2.7L EcoBoost® is deemed "Pocket Hercules." It produces more torque (400 lb.-ft.) than the 5.3L V8 in the 2019 Chevrolet Silverado – an engine nearly twice its size. For exceptional driveability, the 2.7L¹ is paired with our 10-speed automatic transmission with SelectShift capability. "Drop the hammer, and the transmission instantly selects the ideal ratio for peak acceleration from your current speed, always landing in a sweet spot along the broad, flat torque curve and frequently delivering a sharp jolt of acceleration. Yeehaw!" says *Motor Trend*. Strength and durability come from compacted graphite iron (CGI) that forms the upper engine block and cylinders.

Horsepower	325 @ 5,000 rpm
Torque	400 lb.-ft. @ 2,750 rpm
Max. payload capacity ³	2,470 lbs.
Max. towing capacity ³	9,000 lbs.
EPA-estimated ratings ⁴	20 mpg city/26 mpg hwy/22 mpg combined 19 mpg city/24 mpg hwy/21 mpg combined
Induction system	Twin-turbocharged intercooled
Transmission	10-speed SelectShift automatic

○ XL, XLT, LARIAT

5.0L Ti-VCT V8

32 valves. Twin independent variable cam timing. Dual-injection system. 12:1 compression ratio. They all combine to make the trusted 5.0L V8 engine¹ an exceptional choice for all-around F-150 capability. Plus, nothing else sounds quite like it. The V8 is paired with the 10-speed automatic transmission with SelectShift capability.

An available, class-exclusive CNG/Propane Gaseous Engine Prep Package can ready your V8-equipped 2019 F-150 to be upfit for compressed natural gas (CNG), propane autogas, or as a bi-fuel vehicle with the ability to switch between CNG or propane and gasoline.²

Horsepower	395 @ 5,750 rpm
Torque	400 lb.-ft. @ 4,500 rpm
Max. payload capacity ³	3,270 lbs.
Max. towing capacity ³	11,500 lbs.
EPA-estimated ratings ⁴	17 mpg city/23 mpg hwy/19 mpg combined 16 mpg city/22 mpg hwy/18 mpg combined
Induction system	Naturally aspirated
Transmission	10-speed SelectShift automatic

○ XL, XLT, LARIAT, KING RANCH®, PLATINUM

3.5L ECOBOOST

The 3.5L EcoBoost¹ soldiers on for 2019 with a best-in-class 470 lb.-ft. of torque, along with 375 horsepower. Paired with the 10-speed automatic transmission with SelectShift capability, engine torque is readily available across the speed range for instant acceleration and exceptional low-end and peak performance. Exactly what's needed for hauling heavy loads and towing heavy trailers. A roller-finger follower valvetrain features durable intake and exhaust valves, as well as hydraulic valve-lash adjusters that optimize engine durability.

Robust 3.5L EcoBoost engines now power over 1,220,000 F-150 trucks.

Horsepower	375 @ 5,000 rpm
Torque	470 lb.-ft. @ 3,500 rpm
Max. payload capacity ³	3,230 lbs.
Max. towing capacity ³	13,200 lbs.
EPA-estimated ratings ⁴	(4x2) 18 mpg city/25 mpg hwy/21 mpg combined (4x4) 17 mpg city/23 mpg hwy/19 mpg combined
Induction system	Twin-turbocharged intercooled
Transmission	10-speed SelectShift automatic

● STANDARD ○ XL, XLT, LARIAT, KING RANCH, PLATINUM

3.5L H.O. ECOBOOST

Among the High-Output performance enhancements to the RAPTOR and LIMITED 3.5L EcoBoost engine: increased boost calibrations; a lighter turbine wheel made of high-temperature superalloy Mar-M-247 – developed by the aerospace industry – for improved responsiveness; cast stainless steel exhaust manifolds; full dual exhaust; oil-cooled pistons; and more aggressive engine control calibrations.

The close ratio between gears and the Ford patented direct-acting hydraulic control of the 10-speed automatic transmission with SelectShift capability really optimize the power and torque curves of this high-output EcoBoost powerhouse.

Horsepower	450 @ 5,000 rpm ⁵
Torque	510 lb.-ft. @ 3,500 rpm ⁵
Max. payload capacity ³	1,520 lbs.
Max. towing capacity ³	11,100 lbs.
EPA-estimated ratings ⁴	17 mpg city/22 mpg hwy/19 mpg combined 17 mpg city/21 mpg hwy/19 mpg combined ⁶
Induction system	Twin-turbocharged intercooled
Transmission	10-speed SelectShift automatic

● LIMITED, RAPTOR

3.0L POWER STROKE V6 TURBO DIESEL

As the first-ever diesel engine in Ford F-150, the 3.0L Power Stroke® V6 Turbo Diesel¹ features a best-in-class EPA-estimated rating of 30 mpg hwy;⁴ a best-in-class 440 lb.-ft. of diesel torque; and 250 diesel horsepower. Plus, best-in-class diesel payload and towing capacity.³ It's paired with the 10-speed automatic transmission with SelectShift capability to put all that usable low-end engine torque to good use.

With the transmission's 10-speed architecture, and the engine's peak torque arriving at a low 1,750 rpm, this powertrain is an exceptional choice for those who tow and haul frequently – where strong torque delivery throughout the rpm range is exactly what you need.

Horsepower	250 @ 3,250 rpm
Torque	440 lb.-ft. @ 1,750 rpm
Max. payload capacity ³	1,980 lbs.
Max. towing capacity ³	11,300 lbs.
EPA-estimated ratings ⁴	22 mpg city/30 mpg hwy/25 mpg combined 20 mpg city/25 mpg hwy/22 mpg combined
Induction system	Variable-geometry turbocharger, intercooled
Transmission	10-speed SelectShift automatic

○ XL (Fleet only), XLT (Fleet only), LARIAT, KING RANCH, PLATINUM



10-SPEED TRANSMISSION

Standard with five F-150 engines for 2019, the innovative 10-speed automatic transmission with SelectShift® capability helps deliver higher average power for acceleration – improving responsiveness and performance. With optimized gear spacing, including 3 overdrive gears, the 10-speed gearbox helps maximize shift points and gear ratios to optimize power, low-rpm torque and fuel efficiency. For proof, see the Engines charts on the previous page.

10 speeds, plus progressive range select and tow/haul mode, enhance towing confidence. An electronic control system is engineered to help ensure the right gear at the right time, including skip-shift and direct downshift capability. Select the operating range for automatic shifting (in Drive) thanks to progressive range select. Combined with SelectShift operation in manual mode, the 10-speed delivers an exceptional level of driver control.

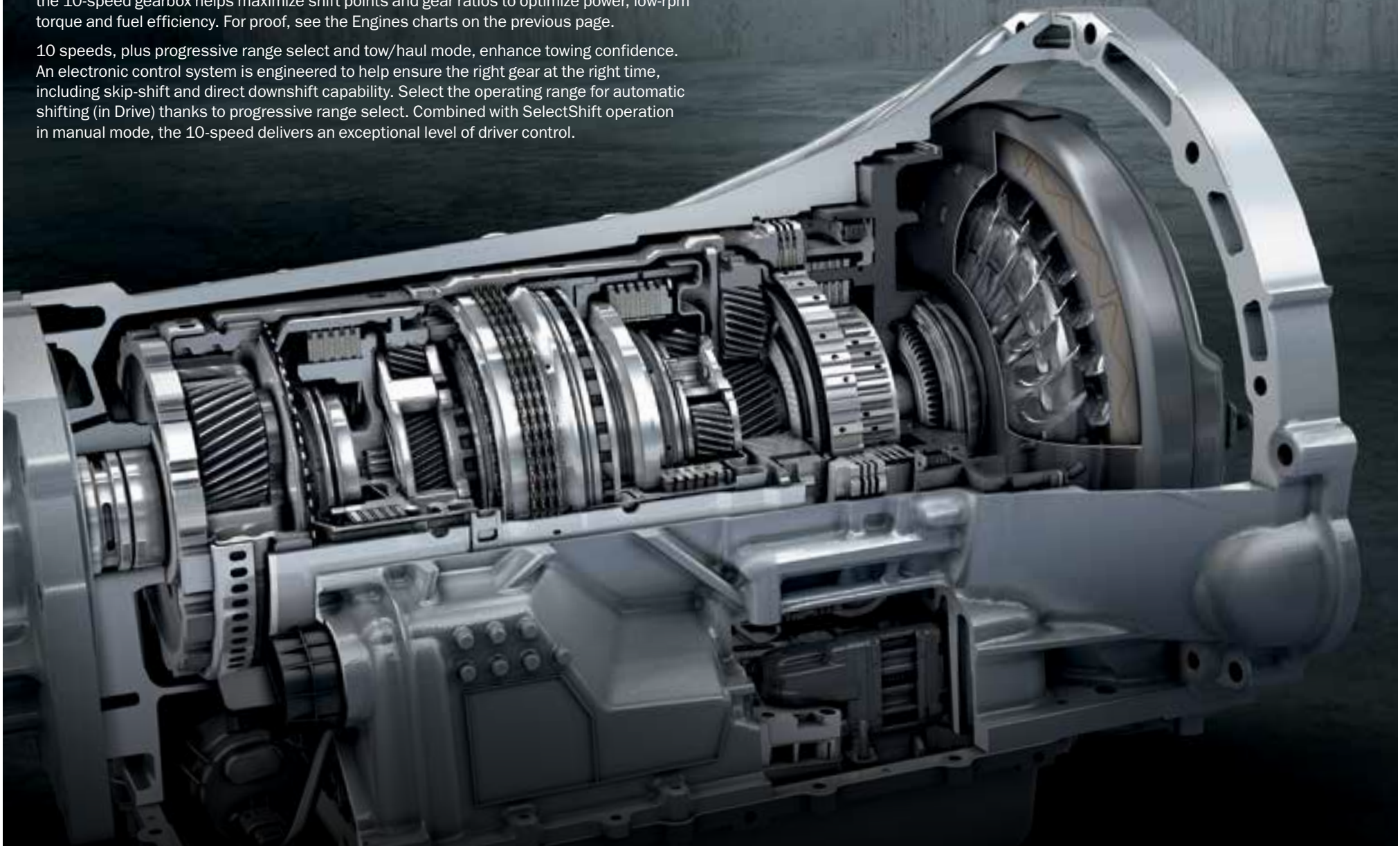

TOW LIKE THE CHAMP

With the high-strength-steel frame, choice of torque-heavy engines,¹ and smart towing technology of the 2019 Ford F-150, you are the greatest. Tow a class-best max. towing capacity of 13,200 lbs.² when equipped with the 3.5L EcoBoost® engine¹ and Max. Trailer Tow Package.

Plus, F-150 is available with multiple Ford Co-Pilot360™ Technology driver-assist features, including Pro Trailer Backup Assist™ (PTBA),¹ Trailer Sway Control, BLIS® with Trailer Coverage,^{4,3} and Hill Start Assist³ – which helps prevent you from rolling back on a grade by momentarily maintaining brake pressure until the engine produces enough torque to move F-150 uphill. Class-exclusive PowerScope® power-telescoping/-folding trailer tow mirrors⁴ and a Smart Trailer Tow Connector⁴ combine with the stabilization benefits of an integrated trailer brake controller^{1,4} to help further enhance towing confidence. After you're on the move, maintain a consistent speed on steep grades by locking out upper gears using the progressive range select feature on both SelectShift® automatic transmissions. Both also feature tow/haul mode, for use when F-150 is heavily loaded or when towing – which should be often. Remember, you got this, champ.



CLASS-BEST
13,200 LBS.
MAX. TOWING

2019 F-150 | ford.com

LARIAT SuperCrew® 4x4. Blue Jeans. LARIAT Chrome Package. Max. Trailer Tow Package. Available equipment. ¹Available feature. ²SuperCrew 6.5' box 4x2 with 3.5L EcoBoost engine and Max. Trailer Tow Package. Not shown. See Payload and Towing charts in the Specifications section for maximum ratings by configuration. ³Driver-assist features are supplemental and do not replace the driver's attention, judgment and need to control the vehicle. ⁴Trailer brake controller verified to be compatible with electrically actuated drum brakes and certain electric-over-hydraulic brake systems. See your Ford Dealer for details.





CLASS-EXCLUSIVE PRO TRAILER BACKUP ASSIST™^{1,2} (PTBA) makes it easy to back up your trailer. Once the system is programmed,³ simply rotate the PTBA knob left or right depending on the direction you want the trailer to go. The system then automatically steers the truck to turn the trailer the desired amount. PTBA can help you back up your trailer like a pro.



While your sideview mirrors are your primary visual aid, PTBA^{1,2} features a Rear View Camera image⁴ that allows you to view trailer direction and help determine trailer placement. The guidelines of dynamic hitch assist⁴ help you easily line up your truck and trailer. Further assistance is provided by our 360-Degree Camera with Split-View Display^{1,2} that works at low speeds in Forward and Reverse. Four cameras let you see all sides of



Check pressure in each tire⁵ with the standard Individual Tire Pressure Monitoring System. You'll be notified through the productivity screen⁶ if any tire's pressure is low. A numerical value will even tell you how low.

A class-exclusive Smart Trailer Tow Connector¹ provides instrument cluster alerts about trailer connection status, along with lighting and trailer battery alerts and warnings.⁶ If something needs your attention, you'll see it here.

Track towing information,¹ such as profiles for up to 10 different trailers, including accumulated miles on each.⁶





CLASS - BEST
3,270 LBS.
MAX. PAYLOAD

With 3 box lengths ranging from 5.5' to 8', Ford F-150 carries the day with best-in-class payload: 3 times over. When equipped with the muscular 5.0L V8 engine¹ and Heavy-Duty Payload Package, F-150 leads all competitors with a 3,270-lb. max. payload.² Next in line? A similarly equipped F-150 with the 3.5L EcoBoost[®] engine¹ at 3,230 lbs. max. payload.² Following that is an F-150 equipped with the 2.7L EcoBoost engine¹ and Payload Package at 2,470 lbs.² To access the cargo box, steps on all 3 sides¹ include deployable box side steps⁴ for all box lengths.



1. Standard lockable tailgate
2. Industry-first remote tailgate release¹
3. Tailgate step with grab bar¹
4. LED cargo box lighting¹
5. Stowable bed extender¹
6. Class-exclusive stowable loading ramps¹
7. BoxLink™ removable and lockable tie-down cleats (4)¹
8. Aluminum crossbed toolbox by Weather Guard^{®1,2}



TOUGH LOOKS OUT FOR YOU.

Ford Co-Pilot360™ Technology offers you driver-assist features like Pre-Collision Assist with Automatic Emergency Braking (AEB),¹ which can automatically apply F-150 brakes to help prevent a collision with a vehicle or pedestrian.² Additional Ford Co-Pilot360 Technology encourages your alertness,³ warns you of vehicles detected in your blind spots,³ and monitors your truck's position on the road.³ They're constantly at your service as you tow, stay centered in or attempt to change lanes, and keep a preset distance from the vehicle ahead of you.



2019 F-150 | ford.com

KING RANCH® SuperCrew® 4x4. White Platinum/Stone Gray two-tone. KING RANCH Chrome Package. Available equipment. ¹Driver-assist features are supplemental and do not replace the driver's attention, judgment and need to control the vehicle. ²Pre-Collision Assist with AEB can detect pedestrians, but not in all conditions and does not replace safe driving. See owner's manual for system limitations. ³Available feature.



ADAPTIVE CRUISE CONTROL WITH STOP-AND-GO^{1,2} can bring your vehicle to a complete stop when traffic slows, and can accelerate back to its preset speed within 3 seconds of stopping.³

● LIMITED ○ LARIAT, KING RANCH, PLATINUM, RAPTOR

LANE-KEEPING SYSTEM^{1,4} monitors lane markings and can prompt you to steer back toward center if it detects F-150 drifting unintentionally out of its lane. Driver Alert^{1,2} can even warn you in the message center if you could use a break from driving.

● LIMITED ○ LARIAT, KING RANCH, PLATINUM, RAPTOR

ELECTRIC POWER-ASSISTED STEERING supplies precise road feel. And because it uses an electric motor instead of a hydraulic pump, steering control can be programmed and utilized by F-150 systems such as Active Park Assist² and the segment-first Pro Trailer Backup Assist^{™2}

● ALL TRIMS

CROSS-TRAFFIC ALERT^{1,2} warns you of vehicles approaching from the sides while backing up at low speeds.

● PLATINUM, LIMITED ○ XLT, LARIAT, KING RANCH, RAPTOR

BLIS[®] (BLIND SPOT INFORMATION SYSTEM) WITH TRAILER COVERAGE^{1,5} warns you if it detects a vehicle in either of your blind spots while driving forward. Its range can be extended for F-150 to include a conventional trailer, once programmed into the system.

● PLATINUM, LIMITED ○ XLT, LARIAT, KING RANCH, RAPTOR

PRE-COLLISION ASSIST WITH AUTOMATIC EMERGENCY BRAKING^{1,6} can automatically apply the brakes to help reduce the severity of, and in some cases potentially eliminate, a frontal collision with a vehicle traveling in the same direction, or a pedestrian detected ahead.

● ALL TRIMS

CURVE CONTROL⁷ can actually sense when you're taking a turn too fast. When it does, the system can slow the truck's speed as much as 10 mph in about a second to help you maintain control.

● ALL TRIMS

ADVANCETRAC[®] WITH RSC[®] (Roll Stability Control[™])⁷ helps keep all 4 wheels firmly planted by selectively applying individual brakes and modifying engine power – enhancing stability in a wide range of driving conditions.

● ALL TRIMS

TRAILER SWAY CONTROL⁷ monitors the motions of F-150 when towing to detect trailer sway. If detected, the system selectively applies brakes as needed to help you maintain control of the truck and the trailer.

● ALL TRIMS

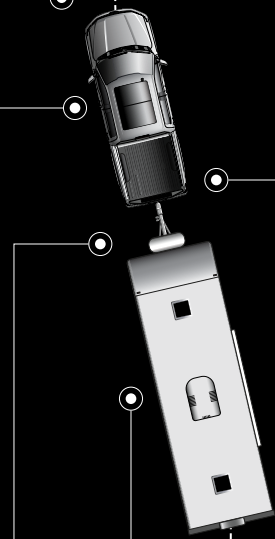

● STANDARD ○ AVAILABLE

2019 F-150 | ford.com

¹Driver-assist features are supplemental and do not replace the driver's attention, judgment and need to control the vehicle. ²Available feature. ³If stop is longer than 3 seconds, driver must intervene and press "RES" button or accelerator pedal to resume system operation. ⁴Available feature. Lane-Keeping System does not control steering. ⁵Available feature. BLIS replaces standard integrated blind spot mirrors. ⁶Pre-Collision Assist with AEB can detect pedestrians, but not in all conditions and does not replace safe driving. See owner's manual for system limitations. ⁷Remember that even advanced technology cannot overcome the laws of physics. It's always possible to lose control of a vehicle due to inappropriate driver input for the conditions.





F-150 LIMITED. LUXURY WITH A NEW SOUL.

Power-deployable running boards extend for your feet, while door-sill scuff plates with Ice Blue® backlit LIMITED lettering usher the way inside. New Camelback two-tone premium luxury leather trims the heated and ventilated 10-way power front bucket seats with LIMITED badging, the heated steering wheel, and the center console lid – where a unique VIN plate reminds you how special this F-150 really is. Not that you'll need reminders as you punch the accelerator and the High-Output 3.5L EcoBoost® engine sends the rpm – and your pulse – climbing. Luxury pickup redefined. Yet again.



The SuperCrew® cab of F-150 is a comfortable place to spend time, whether you're seated in the front or rear. "The SuperCrew is extremely roomy, with rear-seat legroom that bests some full-size sedans," says Kelley Blue Book's KBB.com.⁴ In fact, SuperCrew and SuperCab models with the 40/20/40 split front-seat configuration can accommodate up to 6.

On LIMITED, new Camelback two-tone leather trim covers the multicontour front bucket seats featuring Active Motion® and LIMITED badging. A vast twin-panel moonroof covers the cab, ambient lighting covers the mood, while a B&O Sound System handles the music. A 9-channel amplifier pumps 750 watts of digitally processed sound through 10 high-performance speakers, including 4 midwoofers and a subwoofer.

Tough has never looked, or sounded, better.

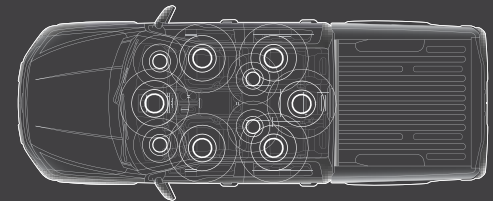

HEATED, LEATHER-WRAPPED STEERING WHEEL
AND POWER-TILT/-TELESCOPING STEERING COLUMN WITH MEMORY

● KING RANCH, PLATINUM, LIMITED ○ LARIAT, RAPTOR

HEATED AND VENTILATED
10-WAY POWER-ADJUSTABLE FRONT SEATS

● LARIAT, KING RANCH, PLATINUM, LIMITED ○ RAPTOR

FIRST-IN-CLASS INFLATABLE
REAR OUTBOARD SAFETY BELTS (SuperCrew only)

● PLATINUM, LIMITED ○ XLT, LARIAT, KING RANCH, RAPTOR

HEATED REAR OUTBOARD SEATS
(SuperCrew only)

● KING RANCH, PLATINUM, LIMITED ○ LARIAT, RAPTOR

● STANDARD ○ AVAILABLE

2019 F-150 | ford.com

LIMITED SuperCrew 4x4. Camelback two-tone leather-trimmed interior. Available equipment. ⁴From KBB Expert Reviews on Kelley Blue Book's KBB.com.





IT ALL STARTS HERE

This vibrant 8" touchscreen is the command center of SYNC® 3 voice-activated technology,^{1,2} which integrates your paired mobile phone with Ford F-150 as soon as you start your truck. Make calls. Send and receive text messages. And so much more. Just swipe left or right, or use simple voice commands, to help ensure that your life doesn't miss a beat. SYNC 3 also features 2 smart-charging USB ports to help keep your devices powered up.

LINK YOUR APPS

SYNC 3 AppLink³ links your favorite compatible mobile apps with your voice, giving you convenient control. iPhone® users can view the Waze™ app's community-based navigation and traffic features⁴ on the large SYNC 3 touchscreen. Amazon Alexa users can access thousands of skills and services they enjoy on their Amazon Echo with the Ford+Alexa⁵ app.

CONNECT TO FORDPASS CONVENIENCE

FordPass Connect™ with 4G LTE Wi-Fi hotspot^{2,6} lets passengers connect tablets, laptops and smartphones. It includes a complimentary 3-month or 3GB data trial. And that's only part of its convenience. Together with the FordPass™ smartphone app,⁷ FordPass Connect allows you to remotely start² your truck and climate control system using your smartphone. As well as locate your vehicle and check approximate fuel range. FordPass also helps you find fuel and compare prices. Find, reserve and pre-pay for parking in select locations. Plus, get help 24/7 from our trained team of Ford Guides.

CONNECT YOUR iPhone

Apple CarPlay™ compatibility^{2,8} displays the iPhone interface on your vehicle's touchscreen. Send and receive text messages by voice. Get where you're going with Apple® Maps or your favorite supported app, including Google Maps™, Waze and more. Access playlists from Apple Music.® Just ask Siri® for help. She already knows your voice.

CONNECT YOUR ANDROID PHONE

Android Auto™ compatibility^{2,8} displays the Android™ interface on your vehicle's touchscreen. Get voice-guided navigation from Google Maps and Waze. Access your favorite music from your apps. Make calls. Send and receive messages. Just talk to Google Assistant™ and go.

MAP YOUR ROUTE

Voice-activated navigation² delivers turn-by-turn directions and vivid 3-D maps on the SYNC 3 touchscreen. Pinch-to-zoom capability allows for a closer look. SiriusXM® Traffic and Travel Link^{9,9} helps you avoid traffic – before you're in the middle of it. It also provides fuel prices and station locations. Current and forecasted weather. Movie locations and showtimes. Plus, the scores of your favorite sports teams, and more.

STAY CONNECTED ON THE MOVE



2019 F-150 | ford.com

¹Don't drive while distracted. Use voice-operated systems when possible; don't use handheld devices while driving. Some features may be locked out while the vehicle is in gear. Not all features are compatible with all phones. ²Available feature. ³Certain restrictions, 3rd-party terms and data rates may apply. See your Ford Dealer for details. Commands may vary by phone and AppLink software. ⁴Available via iPhone with SYNC 3 with Software Version 3.0. Waze is also available on Android Auto. Commands may vary by phone and AppLink software. ⁵Certain Alexa functionality is dependent on smart phone and home technology. ⁶Certain restrictions, 3rd-party terms and data rates may apply. See footnotes 1 and 2 on XLT Features pages, and your Ford Dealer for details. ⁷Available via download and compatible with select smartphone platforms. Learn more at fordpass.com. Message and data rates may apply. ⁸Requires phone with active data service and compatible software. SYNC does not control 3rd-party products while in use. ⁹3rd parties are solely responsible for their respective functionality. ⁹Certain restrictions, 3rd-party terms and data rates may apply. See footnote 2 on page 25, and your Ford Dealer for details.





Its capability: legendary. But that didn't stop us from sharpening its talons. 2019 RAPTOR upgrades include the new Trail Control™ system that helps provide maximum traction whenever you venture beyond the pavement. Which will be often. Designed for low-traction, off-road conditions, Trail Control manages acceleration and braking – sending power and braking to each individual wheel as needed – so you can keep your focus on steering over rugged terrain. New FOX Racing Shox™ 3.0 internal bypass shock absorbers feature all-new, electronically controlled Live Valve technology to continually adjust damping in real-time. Sensors in the suspension and body help the shocks maximize handling, comfort and bottom-out resistance on rugged, off-road terrain, while also smoothing out on-road driving performance. Inside, new RECARO® sport front seats¹ with enhanced bolstering in the seat back and cushion provide aggressive styling and comfortable support. Bold new exterior colors include Ford Performance Blue, Velocity Blue and Agate Black.

RAPTOR

Its hardware reads like an off-roader's wish list. High-Output 3.5L EcoBoost® engine. 4-wheel drive (4WD), Torque-On-Demand® transfer case. Suspension travel of 13" in front and 13.9" in the rear. BFGoodrich® KO2 tires. Bead-lock-capable wheels.¹ 6 auxiliary switches in the overhead console from which to direct all the fun. Plus, the upgrades at right for 2019.

CLASS - BEST
510 LB.-FT. TORQUE²

CLASS - BEST
450 HORSE POWER²



GIVE ME THE SPECIAL.

Add special effects to your F-150 with the XLT and LARIAT Special Edition Packages, which merge Red and Black in dramatic ways. Outside and in. Dark headlamp housings, a dark honeycomb grille, unique bodyside and hood decals, black running boards, plus 20" premium Tarnished Dark-painted aluminum wheels cast a menacing look at street level. Inside, unique accents, finishes and steering wheel complement the exclusive Special Edition Black seats with Red accents.



STEALTH MODE: If you prefer, a Graphic Delete option lets you order the Special Edition Package without hood and bodyside decals.



A TOUCH OF SWAGGER.

Along with confident capability. That's STX appeal. Its signature look is defined by a monochromatic exterior, black honeycomb grille with body-color surround, fog lamps, rear privacy glass, STX cargo box decals, and 20" machined aluminum wheels. Inside, you'll find unique black sport cloth-trimmed seating. Take it up a notch with front bucket seats⁴ and a flow-through center console.¹ Style that works is always appealing.



TOUGH X 7



XL

Featuring a black grille and bumpers, plus black vinyl flooring, this no-nonsense work truck is the bedrock of the F-150 lineup. With all the capability and standard features to get you comfortably through any work week. "We were ... wowed by the capability of the basic F-150 work truck," says *Motor Trend*. "Everything works. Nothing is luxe. That's the way it is supposed to be - functional."

Regular Cab 4x4. Oxford White. Available equipment.

XLT

Takes all the great features of XL and adds just the right level of refinement with its substantial list of popular standards. Like a chrome grille and bumpers. Carpeted flooring. Power windows and door locks. Power tailgate lock. SYNC® 3. FordPass Connect™ with 4G LTE Wi-Fi hotspot.¹ Its wide range of cabs, cargo boxes and content options make F-150 XLT an incredibly versatile truck that's a great addition to any lineup.

SuperCrew® 4x4. Ingot Silver. Chrome Package. Available equipment.



LARIAT

Its standards put you at ease behind the wheel, so you're always ready to tackle the day. Leather-trimmed, heated and ventilated 10-way power-adjustable front seats and power-adjustable pedals help drivers of all sizes feel at home. An 8" LCD productivity screen puts vital vehicle information front and center. Listen to your favorite channels of SiriusXM.² Help keep things secure out back with class-exclusive BoxLink™ with premium locking cleats.

SuperCrew 4x4. Ruby Red. Sport Package. Available equipment.

KING RANCH

Conveys Southwestern luxury at its finest, starting with the standard two-tone exterior. Inside, Kingsville leather trim covers the heated and ventilated 10-way power front seats, flow-through console lid and heated steering wheel. Seat backs, floor mats, center console lid, and 18" machined aluminum wheels with painted pockets are branded with the "Running W" logo of the historic King Ranch® in Texas. Voice-activated Navigation with SiriusXM® Traffic and Travel Link® helps guide you on your way. While a B&O Sound System supplies the soundtrack.

SuperCrew® 4x4. White Platinum/Stone Gray two-tone.
Available equipment.



PLATINUM

A cut above, with standard LED lighting all around (headlamps, fog lamps and taillamps), as well as 20" polished aluminum wheels. Power-deployable running boards give you a lift inside, where multicontour premium leather-trimmed front bucket seats with Active Motion® are available in Dark Marsala or Black. Class-exclusive LED sideview mirror spotlights, along with BLIS® with Trailer Coverage, improve on your powerful capability. The 2019 F-150 PLATINUM.

SuperCrew 4x4. Magma Red.
Available equipment.

LIMITED

Don't let its opulence fool you. LIMITED comes ready to work with the High-Output 3.5L EcoBoost® engine, mechanical-locking 4WD, and multiple Ford Co-Pilot360™ Technology driver-assist features. All standard. As well as a truckload of amenities that includes 22" polished aluminum wheels, heated rear outboard seats, and a unique LIMITED VIN plate on the leather-trimmed center console lid. When you demand nothing but the best, step up to LIMITED.

SuperCrew 4x4. Agate Black.
Available equipment.



RAPTOR

There's nothing else like it. And probably never will be. A Terrain Management System™ with 7 selectable drive modes allows you to optimize the Baja-bred RAPTOR to current driving conditions. New Trail Control™ plus new FOX Racing Shox™ 3.0 internal bypass shocks with all-new, electronically controlled Live Valve technology, improve its already monstrous capability beyond the pavement. How is that even possible? You'll have to experience RAPTOR for yourself. Lean, mean, and ready to scream, this beast just keeps getting better and better.

SuperCrew 4x4. Velocity Blue. Available equipment.



STANDARD FEATURES

MECHANICAL

- 2-stage variable-rate leaf spring rear suspension
- 4-pin trailer tow wiring with ball-mounting provisions in rear bumper
- 4-wheel vented disc brakes with Anti-Lock Brake System (ABS) and electronic brakeforce distribution (EBD)
- 100,000-mile tune-up interval (under normal driving conditions with routine fluid and filter changes)
- Active Grille Shutters
- Auto Start-Stop Technology
- Easy Fuel[®] capless fuel filler
- Electric power-assisted rack-and-pinion steering
- Electronic parking brake
- Fail-Safe Engine Cooling System
- Front stabilizer bar
- Fully boxed steel frame
- Long-spindle, double-wishbone, coil-over-shock, independent front suspension
- Spare wheel and tire with lock and rear underframe carrier

FORD CO-PILOT360™ TECHNOLOGY

- AdvanceTrac[®] with RSC[®] (Roll Stability Control™)
- Autolamp Automatic On/Off Headlamps with Auto High Beams
- Curve Control
- Hill Start Assist
- Pre-Collision Assist with Automatic Emergency Braking (AEB)
- Rear View Camera with dynamic hitch assist
- SOS Post-Crash Alert System™
- Trailer sway control

INTERIOR

- 12V powerpoint
- Air conditioning
- Driver and front-passenger grab handles, and rear-passenger on SuperCrew[®]
- Driver and front-passenger sun visors
- Gauges for fuel, oil pressure, transmission and engine coolant temperature; tachometer; speedometer; and odometer
- LED front dome/map lights
- Outside temperature display

EXTERIOR

- Center high-mounted stop lamp (CHMSL) with cargo lamp
- Configurable daytime running lamps
- Pickup box rail and tailgate moldings
- Pickup box tie-down hooks (4)
- Removable tailgate with key lock
- Variable-intermittent windshield wipers with washers

SAFETY & SECURITY

- Personal Safety System™ for driver and right-front passenger includes dual-stage front airbags¹; safety belt pretensioners, safety belt energy-management retractors, safety belt usage sensors, driver's seat position sensor, crash severity sensor, restraint control module and Front-Passenger Sensing System
- Front-seat side airbags¹ and Safety Canopy[®] System with side-curtain airbags¹ and rollover sensor
- 3-point safety belts in front (all models) and rear (SuperCab and SuperCrew)
- Individual Tire Pressure Monitoring System (excludes spare)
- SecuriLock[®] Passive Anti-Theft System

XL

4x2 | STANDARD

4x4 | AVAILABLE



3.3L Ti-VCT V6 FFV
Standard: Regular Cab,
SuperCab 6.5' Box,
SuperCrew® 5.5' Box

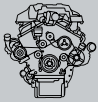

2.7L EcoBoost® V6
Standard: SuperCab 8' Box 4x2,
SuperCrew 6.5' Box 4x2
Available: Regular Cab,
SuperCab 6.5' Box,
SuperCrew 5.5' Box



5.0L Ti-VCT V8 FFV
Standard: SuperCab 8' Box 4x4,
SuperCrew 6.5' Box 4x4
Available: Regular Cab,
SuperCab, SuperCrew



3.5L EcoBoost V6
Available: Regular Cab 8' Box,
SuperCab, SuperCrew



**3.0L Power Stroke® V6
TURBO DIESEL**
Available (Fleet only):
SuperCab 6.5' Box, SuperCrew

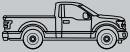

REGULAR CAB | 6.5' Box

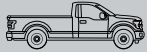

REGULAR CAB | 8' Box

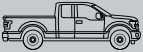

SUPERCAB | 6.5' Box

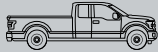

SUPERCAB | 8' Box

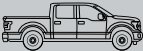

SUPERCREW | 5.5' Box

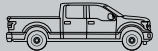

SUPERCREW | 6.5' Box



**40/20/40
SPLIT FRONT SEAT**
Standard



**FRONT BUCKET SEATS
WITH CENTER CONSOLE**
Available



STANDARD



CHROME PACKAGE



SPORT PACKAGE



STX PACKAGE



XL

XL (EQUIPMENT GROUP 100A)
INCLUDES STANDARD FEATURES, PLUS:

MECHANICAL

Electronic shift-on-the-fly (ESOF) transfer case with neutral towing capability (4x4)

Fuel tank – 23-gallon (Regular Cab/SuperCab)

Fuel tank – 26-gallon (SuperCrew®)

Gas-pressurized twin-tube front and staggered, outboard-mounted rear shock absorbers

Jack

Rear axle – 3.15 non-limited-slip (4x2 with 5.0L and 3.5L EcoBoost® engines)

Rear axle – 3.31 non-limited-slip¹ (3.0L diesel, and 4x4 with 5.0L and 3.5L EcoBoost engines)

Rear axle – 3.55 non-limited-slip¹ (3.3L and 2.7L EcoBoost engines)

Rear axle – 3.73 non-limited-slip¹ (3.3L engine)

SEATING

Cloth-trimmed seats

40/20/40 split front seat and folding armrest with storage

2-way manual driver and right-front-passenger seats

60/40 split one-touch flip-up rear seat (SuperCab/SuperCrew)

INTERIOR

AM/FM stereo (includes 4 speakers on Regular Cab; 6 speakers on SuperCab/SuperCrew)

2.3" productivity screen in instrument cluster

4.2" screen in center stack

Auxiliary audio input jack (n/a with SYNC®)

Black vinyl flooring

Fixed rear window with solar-tinted glass

Manual-tilt/-telescoping steering column

Steering column-mounted shifter

EXTERIOR

Black front tow hooks (4x4)

Black grille, bumpers, door and tailgate handles, and sideview mirror caps

Halogen headlamps

Mirrors – Manual-folding sideview with manual glass

AVAILABLE FEATURES AND PACKAGES:

MECHANICAL

Engine block heater¹

Fuel tank – 36-gallon extended-range¹ (n/a with 3.0L diesel engine)

Rear axle – 3.15 electronic-locking (4x2 with 3.5L EcoBoost engine)

Rear axle – 3.31 electronic-locking¹ (5.0L, 3.0L diesel, and 4x4 with 3.5L EcoBoost engines)

Rear axle – 3.55 electronic-locking¹

Rear axle – 3.73 electronic-locking¹

Trailer brake controller¹

FORD CO-PILOT360™ TECHNOLOGY

Reverse Sensing System¹

SEATING

Cloth-trimmed front bucket seats with flow-through center console with lockable storage and 2 rear-facing powerpoints¹ (SuperCab/SuperCrew)

Vinyl-trimmed 40/20/40 split front seat (includes vinyl rear seat)

INTERIOR

SiriusXM® with 6-month All Access trial subscription^{1,2}

Audio Upgrade by KICKER® includes 8" subwoofer and an integrated 100-watt digital amplifier¹ (SuperCab/SuperCrew)

110V/400W AC power outlet¹ (1 on center stack; 1 additional on back of center console with front bucket seats; SuperCab/SuperCrew)

Carpet with carpeted floor mats¹

Fixed rear window with privacy glass and defroster

Floor liners¹ (SuperCab/SuperCrew)

Smoker's Pack with ash cup/coin holder

EXTERIOR

Bed divider¹

Bedliner – Plastic drop-in

Bedliner – Tough Bed® spray-in

Box side steps

BoxLink™ with 4 premium locking cleats

Cab steps – Black platform running boards

Front license plate bracket (standard where required)

Halogen fog lamps¹

Mirrors – Manual-folding sideview with power, heated glass, high-intensity LED security approach lamps, LED spotlights, integrated turn signal indicators, and driver's side auto-dimming feature; and interior auto-dimming rearview mirror¹

Mirrors – Manual-folding/-telescoping trailer tow with power, heated glass, high-intensity LED security approach lamps, LED spotlights, and integrated turn signal indicators¹

Skid plates for front differential, transfer case and fuel tank¹ (4x4)

Stowable loading ramps¹

Tailgate step with tailgate lift assist

Tonneau cover – Hard-folding^{1,3}

Tonneau cover – Soft-folding^{1,3}

Toolbox – Aluminum crossbed¹

Toolbox – Premium aluminum crossbed¹

EQUIPMENT GROUP

Equipment Group 101A: XL Power Equipment Group includes power door and tailgate locks with autolock; Remote Keyless Entry System; power windows; manual-folding sideview mirrors with power glass; Illuminated Entry System; MyKey®; and perimeter alarm + cruise control + 4.2" productivity screen in instrument cluster + SYNC Voice Recognition Communications and Entertainment System with 4.2" LCD screen in center stack, 911 Assist®, AppLink®, and 1 smart-charging USB port

PACKAGES

Chrome Package:¹ 17" Silver-painted aluminum wheels, body-color front fascia, chrome bumpers, and halogen fog lamps

Sport Package:¹ 17" Silver-painted aluminum wheels, body-color front fascia and bumpers, halogen fog lamps, and SPORT box decals (decals n/a with FX4 Off-Road Package)

STX Package¹ (SuperCab/SuperCrew): 20" machined aluminum wheels with Flash Gray-painted pockets, 275/55R20 BSW all-season tires (4x2), 275/55R20 BSW all-terrain tires (4x4), black honeycomb grille with body-color surround, body-color front fascia and bumpers, halogen fog lamps, STX cargo box decals (n/a with FX4 Off-Road Package), SYNC 3 with 8" LCD capacitive touchscreen in center stack, 911 Assist, AppLink, Apple CarPlay™ compatibility, Android Auto™ compatibility, and 2 smart-charging USB ports, STX black sport cloth-trimmed seats, manual driver and front-passenger lumbar, front seat back map pockets, rear privacy glass, and rear-window defroster

Capability Packages: content can be found on page 43



XLT

4x2 | STANDARD

4x4 | AVAILABLE



3.3L TI-VCT V6 FFV
Standard: Regular Cab,
SuperCab 6.5' Box,
SuperCrew® 5.5' Box

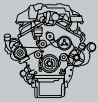

2.7L ECOBOOST® V6
Standard: SuperCab 8' Box 4x2,
SuperCrew 6.5' Box 4x2
Available: Regular Cab,
SuperCab 6.5' Box,
SuperCrew 5.5' Box



5.0L TI-VCT V8 FFV
Standard: SuperCab 8' Box 4x4,
SuperCrew 6.5' Box 4x4
Available: Regular Cab,
SuperCab, SuperCrew



3.5L ECOBOOST V6
Available: Regular Cab 8' Box,
SuperCab, SuperCrew



**3.0L POWER STROKE® V6
TURBO DIESEL**
Available (Fleet only):
SuperCab 6.5' Box, SuperCrew

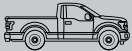

REGULAR CAB | 6.5' Box

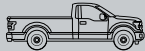

REGULAR CAB | 8' Box

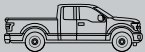

SUPERCAB | 6.5' Box

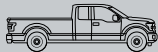

SUPERCAB | 8' Box

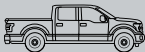

SUPERCREW | 5.5' Box

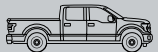

SUPERCREW | 6.5' Box



**40/20/40
SPLIT FRONT SEAT**
Standard



**FRONT BUCKET SEATS
WITH CENTER CONSOLE**
Available



STANDARD



CHROME PACKAGE



SPORT PACKAGE



SPECIAL EDITION
PACKAGE



XLT (EQUIPMENT GROUP 300A)
INCLUDES SELECT XL FEATURES, PLUS:

SEATING

40/20/40 split front seat, center under-seat lockable storage with 12V powerpoint, and folding armrest with cupholders and storage

Driver and right-front-passenger manual lumbar

4-way adjustable driver and right-front-passenger head restraints

INTERIOR

Accessory delay for power features

Carpet with carpeted floor mats

Cruise control

Fixed rear window with privacy glass

FordPass Connect™¹ with 4G LTE Wi-Fi hotspot powered by FordPass™ app²

Illuminated Entry System

MyKey® technology to help encourage responsible driving

Power door and tailgate locks with autolock

Power windows with front one-touch-up/-down feature

SYNC® 3 with 8" LCD capacitive touchscreen in center stack, 911 Assist® AppLink® Apple CarPlay™ compatibility, Android Auto™ compatibility, and 2 smart-charging USB ports

EXTERIOR

Chrome grille and bumpers

Halogen fog lamps

Manual-folding sideview mirrors with power glass

Perimeter alarm

Remote Keyless Entry System

SecuriCode™ keyless entry keypad

AVAILABLE FEATURES AND PACKAGES:

MECHANICAL

Engine block heater³

Fuel tank – 36-gallon extended-range³

Rear axle – 3.15 electronic-locking (4x2 with 3.5L EcoBoost® engine)

Rear axle – 3.31 electronic-locking³ (5.0L, 3.0L diesel, and 4x4 with 3.5L EcoBoost engines)

Rear axle – 3.55 electronic-locking³

Rear axle – 3.73 electronic-locking³

Trailer brake controller³

FORD CO-PILOT360™ TECHNOLOGY

BLIS® (Blind Spot Information System) with Trailer Coverage and Cross-Traffic Alert³

Reverse Sensing System³

SEATING

Front bucket seats with flow-through center console with lockable storage and 2 rear-facing powerpoints³ (SuperCab/SuperCrew®)

INTERIOR

Voice-activated Navigation System with pinch-to-zoom capability, and integrated SiriusXM® Traffic and Travel Link® services with 5-year subscription^{3,4}

110V/400W AC power outlet³ (1 on center stack; 1 additional on back of center console; SuperCab and SuperCrew)

Black vinyl flooring³

Floor liners³ (SuperCab/SuperCrew)

Inflatable rear safety belts in outboard seating positions³ (SuperCrew)

Power-sliding rear window with privacy glass and defroster³ (SuperCab/SuperCrew)

Rear-window defroster

Remote Start System³

Smoker's Pack with ash cup/coin holder

EXTERIOR

Bed divider³

Bedliner – Plastic drop-in

Bedliner – Tough Bed® spray-in

Box side steps³

BoxLink™ with 4 premium locking cleats

Cab steps – Black platform running boards³

Cab steps – Chrome step bars³ (SuperCab/SuperCrew)

Front license plate bracket (standard where required)

LED cargo box lighting³

LED sideview mirror spotlights with high-intensity LED security approach lamps³

Mirrors – Manual-folding sideview with power, heated glass and integrated turn signal indicators; and auto-dimming rearview mirror³

Mirrors – Manual-folding/-telescoping trailer tow with power, heated glass, high-intensity LED security approach lamps, LED spotlights, and integrated turn signal indicators³

Rear wheel-well liners³

Stowable bed extender³

Stowable loading ramps³

Tailgate step with tailgate lift assist³

Tonneau cover – Hard-folding^{3,5}

Tonneau cover – Soft-folding^{3,5}

Toolbox – Aluminum crossbed³

Toolbox – Premium aluminum crossbed³

Twin-panel moonroof³ (SuperCrew)

Two-tone paint with Magnetic lower accent color³ (includes Magnetic bumpers unless Chrome Package is ordered)

EQUIPMENT GROUPS

Equipment Group 301A: rear-window defroster + 8-way power driver's seat + 4.2" productivity screen in instrument cluster + manual-folding sideview mirrors with power, heated glass and integrated turn signal indicators + auto-dimming rearview mirror + leather-wrapped steering wheel + power-adjustable pedals (SuperCab/SuperCrew) + rear underseat storage (SuperCab/SuperCrew) + SiriusXM with 6-month All Access trial subscription⁴ + 7 audio system speakers

Equipment Group 302A (SuperCab/SuperCrew): includes all content of 301A + **Chrome Package** (see content below) + Remote Start System + 10-way power, heated driver and right-front-passenger seats

PACKAGES

XLT Power Equipment Group:³ 110V/400W AC power outlet (1 on center stack; 1 additional on back of center console with front bucket seats), power-sliding rear window with privacy glass and defroster, and LED cargo box lighting

Chrome Package³ (SuperCab/SuperCrew): 18" chrome-like PVD wheels with 265/60R18 BSW all-season (4x2) or 275/65R18 OWL all-terrain (4x4) tires; chrome grille with silver accents; chrome front tow hooks (4x4), door and tailgate handles, step bars and exhaust tip

Sport Package³ (SuperCab/SuperCrew): 18" 6-spoke machined aluminum wheels with Magnetic-painted pockets and 265/60R18 BSW all-season (4x2) or 275/65R18 OWL all-terrain (4x4) tires; Magnetic grille and step bars; body-color bumpers, wheel-lip moldings, and door and tailgate handles; SPORT box decals (n/a with FX4 Off-Road Package); chrome exhaust tip; unique finish on instrument panel, media bin lid and doors; black leather-wrapped steering wheel; XLT sport cloth front bucket seats with flow-through center console and floor shifter

Special Edition Package³ (SuperCrew; requires Sport Package): 20" Premium Tarnished Dark-painted aluminum wheels with 275/55R20 BSW all-season (4x2) or 275/55R20 BSW all-terrain (4x4) tires; black honeycomb grille with body-color surround; dark headlamp housings; unique bodyside and hood decals;⁶ unique fender and tailgate badging; black running boards; black leather-wrapped steering wheel with red stitching; unique finish on instrument panel, media bin lid and doors; XLT Special Edition black sport cloth front bucket seats with red stitching and flow-through center console with floor shifter

Capability Packages: content can be found on page 43

¹FordPass Connect includes a complimentary 1-year subscription for remote features, excluding Wi-Fi hotspot, and starts with vehicle sale date. Subscription is subject to compatible 4G network availability. Certain restrictions, 3rd-party terms, or message and data rates may apply. Evolving technology/cellular networks may affect future functionality. Wi-Fi hotspot includes complimentary wireless data trial that begins upon AT&T activation and expires at the end of 3 months or when 3GB of data is used, whichever comes first, but cannot extend beyond the complimentary subscription period for remote features. To activate, go to www.att.com/ford. ²FordPass smartphone app, for use with FordPass Connect, is available via download and compatible with select smartphone platforms. FordPass is on the App Store® and Google Play™. Learn more at fordpass.com. Message and data rates may apply. ³Restrictions may apply. See your dealer for details. ⁴After your trial period ends, SiriusXM audio and data services each require a subscription sold separately, or as a package, by Sirius XM Radio Inc. See SiriusXM Customer Agreement for complete terms at www.siriusxm.com. All fees and programming subject to change. Trial subscriptions not available in AK and HI. ⁵Ford Licensed Accessory. ⁶Bodyside and hood decals delete option available. Restrictions may apply. See your dealer for details.

LARIAT

4x2 | STANDARD

4x4 | AVAILABLE

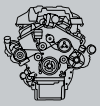

2.7L ECOBOOST® V6

Standard: SuperCab 6.5' Box, SuperCab 8' Box 4x2, SuperCrew® 5.5' Box, SuperCrew 6.5' Box 4x2



5.0L TI-VCT V8 FFV

Standard: SuperCab 8' Box 4x4, SuperCrew 6.5' Box 4x4
Available: SuperCab, SuperCrew

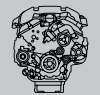

3.5L ECOBOOST V6

Available: SuperCab, SuperCrew

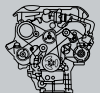

3.0L POWER STROKE® V6 TURBO DIESEL

Available: SuperCab 6.5' Box, SuperCrew

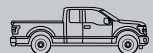

SUPERCAB | 6.5' Box

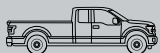

SUPERCAB | 8' Box

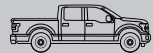

SUPERCREW | 5.5' Box

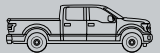

SUPERCREW | 6.5' Box



40/20/40 SPLIT FRONT SEAT

Standard



FRONT BUCKET SEATS WITH CENTER CONSOLE

Available



STANDARD



CHROME PACKAGE



SPORT PACKAGE



SPECIAL EDITION PACKAGE



LARIAT

LARIAT (EQUIPMENT GROUP 500A)
INCLUDES SELECT XLT FEATURES, PLUS:

MECHANICAL

2-speed automatic 4WD system with neutral towing capability (4x4)

Class IV Trailer Hitch with Smart Trailer Tow Connector

Rear axle – 3.15 non-limited-slip (4x2 with 5.0L and 3.5L EcoBoost® engines)

Rear axle – 3.31 non-limited-slip (3.0L diesel, and 4x4 with 5.0L and 3.5L EcoBoost engines)

Rear axle – 3.55 non-limited-slip¹ (2.7L EcoBoost engine)

SEATING

10-way power heated and ventilated driver and right-front-passenger seats

Memory driver's seat

60/40 split one-touch flip-up rear seat with underseat storage (SuperCrew® includes folding armrest with cupholders)

Leather-trimmed front with vinyl rear on SuperCab; leather-trimmed rear on SuperCrew

INTERIOR

SiriusXM® with 6-month All Access trial subscription²

7 audio system speakers

8" productivity screen in instrument cluster

Auto-dimming rearview mirror

Dual-zone electronic automatic temperature control

Ice Blue® ambient lighting

Intelligent Access with push-button start

Leather-wrapped steering wheel with audio controls

Power-adjustable accelerator and brake pedals with memory

Power-sliding rear window with privacy glass and defroster

Woodgrain trim accents

EXTERIOR

Advanced Security Pack includes SecuriLock® Passive Anti-Theft System and inclination/intrusion sensors

Body-color sideview mirror caps, door and tailgate handles, and wheel-lip moldings

BoxLink™ with 4 premium locking cleats

LED cargo box lighting

LED trailer hookup light

Mirrors – Power-folding sideview with power, heated glass, memory, integrated turn signal indicators, high-intensity LED security approach lamps, and driver's side auto-dimming feature

AVAILABLE FEATURES AND PACKAGES:

MECHANICAL

Engine block heater¹

Fuel tank – 36-gallon extended-range¹ (n/a with 3.0L diesel engine)

Rear axle – 3.15 electronic-locking (4x2 with 3.5L EcoBoost engine)

Rear axle – 3.31 electronic-locking (5.0L, 3.0L diesel, and 4x4 with 3.5L EcoBoost engines)

Rear axle – 3.55 electronic-locking¹

Rear axle – 3.73 electronic-locking¹ (5.0L, and 2.7L and 3.5L EcoBoost engines)

Trailer brake controller¹

FORD CO-PILOT360™ TECHNOLOGY

360-Degree Camera with Split-View Display (available in Technology Package)

Active Park Assist (available in Technology Package)

Adaptive Cruise Control with Stop-and-Go¹

BLIS® (Blind Spot Information System) with Trailer Coverage and Cross-Traffic Alert (available in 501A)

Lane-Keeping System (available in Technology Package)

Rain-sensing windshield wipers (available in 502A)

Reverse Sensing System

SEATING

Front bucket seats with flow-through center console with lockable storage, floor shifter, and 2 rear-facing powerpoints¹

INTERIOR

Voice-activated Navigation System with pinch-to-zoom capability, and integrated SiriusXM Traffic and Travel Link® services with 5-year subscription²

110V/400W AC power outlet (1 on center stack; 1 additional on back of center console with front bucket seats)

Floor liners

Inflatable rear safety belts in outboard seating positions¹ (SuperCrew)

Smoker's Pack with ash cup/coin holder

EXTERIOR

Bed divider¹

Bedliner – Plastic drop-in

Bedliner – Tough Bed® spray-in

Box side steps

Cab steps – Chrome angular step bars

Cab steps – Power-deployable running boards¹ (SuperCrew)

Front license plate bracket (standard where required)

LED sideview mirror spotlights with high-intensity LED security approach lamps

Mirrors – PowerScope® power-telescoping/-folding trailer tow with power, heated glass, integrated turn signal indicators, high-intensity LED security approach lamps, LED spotlights, and driver's side auto-dimming feature (requires Trailer Tow Package or Max. Trailer Tow Package)

Rear wheel-well liners¹

Stowable bed extender¹

Stowable loading ramps¹

Tailgate step with tailgate lift assist

Tonneau cover – Hard-folding^{1,3}

Tonneau cover – Soft-folding^{1,3}

Toolbox – Aluminum crossbed^{1,3}

Toolbox – Premium aluminum crossbed^{1,3}

Twin-panel moonroof¹ (SuperCrew)

Two-tone paint with Stone Gray lower accent color¹ (includes Stone Gray bumpers and wheel-lip moldings)

EQUIPMENT GROUPS

Equipment Group 501A: BLIS (Blind Spot Information System) with Trailer Coverage and Cross-Traffic Alert + Remote Start System + remote tailgate release + Reverse Sensing System + power-folding sideview mirrors with power, heated glass, memory, integrated turn signal indicators, high-intensity LED security approach lamps, LED spotlights and driver's side auto-dimming feature + LED taillamps + 110V/400W AC power outlet on center stack + universal garage door opener

Equipment Group 502A:¹ includes all content of 501A + **Chrome Package** (see content under Packages) + 10-way power, heated and ventilated front bucket seats with memory driver's seat and flow-through center console with floor shifter + heated rear outboard seats (SuperCrew) + 110V/400W AC power outlet on back of center console + B&O Sound System with HD Radio™ Technology + power-tilt/-telescoping steering column with memory + heated steering wheel + quad-beam LED headlamps + LED fog lamps + rain-sensing windshield wipers + windshield wiper de-icer

PACKAGES

Chrome Package:¹ 18" chrome-like PVD wheels; chrome grille with silver accents; and chrome front tow hooks (4x4), sideview mirror caps, door and tailgate handles, angular step bars, and exhaust tip

Sport Package:¹ 18" 6-spoke machined aluminum wheels with Magnetic-painted pockets (gas only; diesel requires 20" 6-spoke premium-painted aluminum wheels); body-color grille and bumpers; Magnetic angular step bars; SPORT box decals (n/a with FX4 Off-Road Package); chrome exhaust tip; unique finish on instrument panel, media bin lid and doors; and front bucket seats with flow-through center console and floor shifter

Special Edition Package¹ (SuperCrew; requires Sport Package); 20" premium Tarnished Dark-painted wheels with 275/55R20 BSW all-season (4x2) or 275/55R20 BSW all-terrain (4x4) tires; Dark Foundry honeycomb grille with body-color surround; dark headlamp housings; unique bodyside and hood decals;⁴ unique fender and tailgate badging; black running boards; black leather-wrapped steering wheel with red stitching; unique finish on instrument panel, media bin lid and doors; and LARIAT Special Edition black leather-trimmed front bucket seats with red accents and flow-through center console with floor shifter

Technology Package:⁴ Lane-Keeping System, Active Park Assist, and 360-Degree Camera with Split-View Display

Capability Packages: content can be found on page 43

KING RANCH®

4x2 | STANDARD

4x4 | AVAILABLE



5.0L Ti-VCT V8 FFV
Standard



3.5L ECOBOOST® V6
Available



3.0L POWER STROKE® V6
TURBO DIESEL
Available

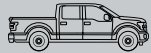

SUPERCREW® | 5.5' Box

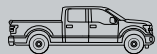

SUPERCREW | 6.5' Box



FRONT BUCKET SEATS
WITH CENTER CONSOLE
Standard



STANDARD



CHROME PACKAGE



MONOCHROME
PACKAGE



KING RANCH®

KING RANCH (EQUIPMENT GROUP 600A)
INCLUDES SELECT LARIAT FEATURES, PLUS:

MECHANICAL

Trailer brake controller

FORD CO-PILOT360™ TECHNOLOGY

Rain-sensing windshield wipers

Reverse Sensing System

SEATING

Front bucket seats with flow-through center console
with lockable storage and 2 rear-facing powerpoints

Heated rear outboard seats

INTERIOR

B&O Sound System with HD Radio™ Technology
and 10 speakers including subwoofer

Voice-activated Navigation System with pinch-to-zoom
capability, and integrated SiriusXM® Traffic and Travel Link®
services with 5-year subscription¹

110V/400W AC power outlets
(1 on center stack and 1 on back of center console)

Center console-mounted floor shifter

Genuine wood interior trim accents

Heated steering wheel

Leather-wrapped center console lid, shift knob
and steering wheel

Metallic door-sill scuff plate inserts with KING RANCH
lettering and running "W" logo

Power-tilt/-telescoping steering column with memory

Universal garage door opener

EXTERIOR

Accent-color 6" angular step bars

Chrome exhaust tip

Chrome grille with accent color mesh

LED fog lamps

LED sideview mirror spotlights with high-intensity LED
security approach lamps

LED taillamps

Quad-beam LED headlamps

Remote Start System

Remote tailgate release

Stone Gray bumpers and wheel-lip moldings

Two-tone paint with Stone Gray lower accent color

Windshield wiper de-icer

AVAILABLE FEATURES AND PACKAGES:

MECHANICAL

Engine block heater²

Fuel tank – 36-gallon extended-range²
(n/a with 3.0L diesel engine)

Rear axle – 3.15 electronic-locking
(4x2 with 3.5L EcoBoost® engine)

Rear axle – 3.31 electronic-locking
(5.0L, 3.0L diesel, and 4x4 with 3.5L EcoBoost engines)

Rear axle – 3.55 electronic-locking²

Rear axle – 3.73 electronic-locking²
(5.0L, and 2.7L and 3.5L EcoBoost engines)

FORD CO-PILOT360 TECHNOLOGY

360-Degree Camera with Split-View Display
(available in Technology Package)

Active Park Assist (available in Technology Package)

Adaptive Cruise Control with Stop-and-Go²

BLIS® (Blind Spot Information System) with Trailer
Coverage and Cross-Traffic Alert (available in 601A)

Lane-Keeping System (available in Technology Package)

INTERIOR

Floor liners

Smoker's Pack with ash cup/coin holder

EXTERIOR

Bed divider²

Bedliner – Plastic drop-in

Bedliner – Tough Bed® spray-in

Box side steps

Front license plate bracket (standard where required)

Mirrors – PowerScope® power-telescoping/-folding trailer
tow with power, heated glass, integrated turn signal
indicators, high-intensity LED security approach lamps,
LED spotlights, and driver's side auto-dimming feature
(requires Trailer Tow Package or Max. Trailer Tow Package)

Rear wheel-well liners

Stowable bed extender

Stowable loading ramps²

Tailgate step with tailgate lift assist

Tonneau cover – Hard-folding^{2,3}

Tonneau cover – Soft-folding^{2,3}

Toolbox – Aluminum crossbed^{2,3}

Toolbox – Premium aluminum crossbed^{2,3}

Twin-panel moonroof

EQUIPMENT GROUP

Equipment Group 601A: tailgate step with tailgate lift
assist + BLIS (Blind Spot Information System) with Trailer
Coverage and Cross-Traffic Alert + multicountour front
bucket seats with Active Motion® + inflatable rear safety
belts in outboard seating positions + power-deployable
running boards + 20" machined aluminum wheels with
Light Caribou-painted pockets + 275/55R20 BSW all-
season (4x2) or 275/55R20 OWL all-terrain (4x4) tires

PACKAGES

Chrome Package:² 20" chrome-like PVD wheels with
275/55R20 BSW all-season (4x2) or 275/55R20 OWL
all-terrain (4x4) tires; chrome bumpers, front tow hooks
(4x4), sideview mirror caps, and door and tailgate
handles; bright beltline moldings; and satin-aluminum
tailgate appliqué

Monochrome Package² (requires KING RANCH Chrome
Package): monochromatic paint with body-color wheel-
lip moldings

Technology Package:² Lane-Keeping System, Active Park
Assist, and 360-Degree Camera with Split-View Display

Capability Packages: content can be found on page 43



PLATINUM

4x2 | STANDARD

4x4 | AVAILABLE



5.0L Ti-VCT V8 FFV
Standard



3.5L ECOBOOST® V6
Available



3.0L POWER STROKE® V6
TURBO DIESEL
Available

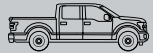

SUPERCREW® | 5.5' Box

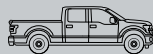

SUPERCREW | 6.5' Box



FRONT BUCKET SEATS
WITH CENTER CONSOLE
Standard



PLATINUM

PLATINUM (EQUIPMENT GROUP 700A)
INCLUDES SELECT LARIAT FEATURES, PLUS:

MECHANICAL

Trailer brake controller

FORD CO-PILOT360™ TECHNOLOGY

BLIS® (Blind Spot Information System) with Trailer Coverage and Cross-Traffic Alert

Rain-sensing windshield wipers

Reverse Sensing System

SEATING

Multicontour front bucket seats with Active Motion® and flow-through center console with lockable storage and 2 rear-facing powerpoints

Heated rear outboard seats

INTERIOR

B&O Sound System with HD Radio™ Technology and 10 speakers including subwoofer

Voice-activated Navigation System with pinch-to zoom capability, and integrated SiriusXM® Traffic and Travel Link® services with 5-year subscription¹

110V/400W AC power outlets
(1 on center stack and 1 on back of center console)

Center console-mounted floor shifter

Genuine wood interior trim accents

Heated steering wheel

Inflatable rear safety belts in outboard seating positions

Leather-wrapped center console lid, shift knob and steering wheel

Metallic door-sill scuff plate inserts with PLATINUM lettering

Power-tilt/-telescoping steering column with memory

Unique gauge cluster face

Universal garage door opener

EXTERIOR

Body-color bumpers

Bright beltline moldings

Chrome front tow hooks (4x4), sideview mirror caps, door and tailgate handles, and exhaust tip

LED fog lamps

LED sideview mirror spotlights with high-intensity LED security approach lamps

LED taillamps

Power-deployable running boards

Quad-beam LED headlamps

Remote Start System

Remote tailgate release

Satin-aluminum grille with silver mesh

Satin-aluminum tailgate appliqué

Windshield wiper de-icer

AVAILABLE FEATURES AND PACKAGES:

MECHANICAL

Engine block heater²

Fuel tank – 36-gallon extended-range²
(n/a with 3.0L diesel engine)

Rear axle – 3.15 electronic-locking
(4x2 with 3.5L EcoBoost® engine)

Rear axle – 3.31 electronic-locking
(5.0L, 3.0L diesel, and 4x4 with 3.5L EcoBoost engines)

Rear axle – 3.55 electronic-locking²

Rear axle – 3.73 electronic-locking²
(5.0L and 3.5L EcoBoost engines)

FORD CO-PILOT360 TECHNOLOGY

360-Degree Camera with Split-View Display
(available in Technology Package)

Active Park Assist (available in Technology Package)

Adaptive Cruise Control with Stop-and-Go
(available in 701A)

Lane-Keeping System (available in Technology Package)

INTERIOR

Floor liners

Smoker's Pack with ash cup/coin holder

EXTERIOR

Bed divider²

Bedliner – Plastic drop-in

Bedliner – Tough Bed® spray-in

Box side steps

Front license plate bracket (standard where required)

Mirrors – PowerScope® power-telescoping/-folding trailer tow with power, heated glass, integrated turn signal indicators, high-intensity LED security approach lamps, LED spotlights, and driver's side auto-dimming feature (requires Trailer Tow Package or Max. Trailer Tow Package)

Rear wheel-well liners

Stowable bed extender

Stowable loading ramps²

Tailgate step with tailgate lift assist

Tonneau cover – Hard-folding^{2,3}

Tonneau cover – Soft-folding^{2,3}

Toolbox – Aluminum crossbed^{2,3}

Toolbox – Premium aluminum crossbed^{2,3}

Twin-panel moonroof

EQUIPMENT GROUP

Equipment Group 701A: Technology Package (see content under Packages) + Adaptive Cruise Control with Stop-and-Go + tailgate step with tailgate lift assist

PACKAGES

Technology Package: Lane-Keeping System, Active Park Assist, and 360-Degree Camera with Split-View Display

Capability Packages: content can be found on page 43



LIMITED

4x2 | STANDARD

4x4 | AVAILABLE



HIGH-OUTPUT
3.5L ECOBOOST® V6
Standard

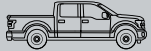

SUPERCREW® | 5.5' Box



FRONT BUCKET SEATS
WITH CENTER CONSOLE
Standard



LIMITED

LIMITED (EQUIPMENT GROUP 900A)
INCLUDES SELECT LARIAT FEATURES, PLUS:

MECHANICAL

2-speed automatic 4WD system with mechanical lock
3.55 electronic-locking rear axle
Fuel tank – 36-gallon extended-range
Trailer brake controller

FORD CO-PILOT360™ TECHNOLOGY

360-Degree Camera with Split-View Display
Active Park Assist
Adaptive Cruise Control with Stop-and-Go
BLIS® (Blind Spot Information System) with Trailer Coverage and Cross-Traffic Alert
Lane-Keeping System
Rain-sensing windshield wipers
Reverse Sensing System

SEATING

Multicontour front bucket seats with Active Motion®, LIMITED seat back badging, and flow-through center console with lockable storage and 2 rear-facing powerpoints
Heated rear outboard seats

INTERIOR

B&O Sound System with HD Radio™ Technology and 10 speakers including subwoofer
Voice-activated Navigation System with pinch-to-zoom capability, and integrated SiriusXM® Traffic and Travel Link® services with 5-year subscription¹
110V/400W AC power outlets (1 on center stack and 1 on back of center console)
Center console-mounted floor shifter
Genuine wood interior trim accents
Heated steering wheel
Inflatable rear safety belts in outboard seating positions
Leather-wrapped center console lid with LIMITED VIN plate
Leather-wrapped shift knob and steering wheel
Metallic door-sill scuff plate inserts with Ice Blue® illuminated LIMITED lettering
Power-tilt/-telescoping steering column with memory
Unique gauge cluster face
Universal garage door opener

EXTERIOR

Body-color bumpers
Bright beltline moldings
Chrome front tow hooks (4x4)
Chrome LIMITED hood lettering
Dual exhaust with satin-chrome tips
LED fog lamps
LED sideview mirror spotlights with high-intensity LED security approach lamps
LED taillamps
Power-deployable running boards
Quad-beam LED headlamps
Rear wheel-well liners
Remote Start System
Remote tailgate release
Satin-aluminum door and tailgate handles
Satin-aluminum grille with chrome and silver accents
Satin-aluminum tailgate appliqué
Twin-panel moonroof
Windshield wiper de-icer

AVAILABLE FEATURES AND PACKAGES:

MECHANICAL

Engine block heater

INTERIOR

Floor liners
Smoker's Pack with ash cup/coin holder

EXTERIOR

Bed divider²
Bedliner – Plastic drop-in
Bedliner – Tough Bed® spray-in
Box side steps
Front license plate bracket (standard where required)
Stowable bed extender
Stowable loading ramps²
Tailgate step with tailgate lift assist
Tonneau cover – Hard-folding²,³
Tonneau cover – Soft-folding²,³
Toolbox – Aluminum crossbed²,³
Toolbox – Premium aluminum crossbed²,³

PACKAGES

Capability Packages: content can be found on page 43



RAPTOR

4x4 | STANDARD



HIGH-OUTPUT
3.5L ECOBOOST® V6
Standard



SUPERCAB | 5.5' Box

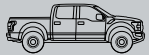

SUPERCREW® | 5.5' Box



FRONT BUCKET SEATS
WITH CENTER CONSOLE
Standard



RECARO® SPORT
FRONT BUCKET SEATS
WITH CENTER CONSOLE
Available



RAPTOR

RAPTOR (EQUIPMENT GROUP 800A)
INCLUDES SELECT XLT FEATURES, PLUS:

MECHANICAL

2-speed automatic Torque-On-Demand® 4WD system with mechanical lock

4.10 electronic-locking rear axle

Electronic shift-on-the-fly (ESOF) with neutral towing capability

FOX Racing Shox™ 3.0 internal bypass shocks with Live Valve technology

Fuel tank - 26-gallon (SuperCab)

Fuel tank - 36-gallon (SuperCrew®)

Heavy-duty jack

Long-travel front suspension with unique front upper and lower control arms and unique tie-rods

Terrain Management System™

Trail Control™

Trailer Tow Package: 4-pin/7-pin wiring harness, Class IV trailer hitch receiver, Smart Trailer Tow Connector, upgraded front stabilizer bar, and trailer hookup lamp

FORD CO-PILOT360™ TECHNOLOGY

Reverse Sensing System

SEATING

Front bucket seats with unique seat back bolsters, and flow-through center console with lockable storage and 2 rear-facing 12V powerpoints

8-way power driver seat and 2-way manual right-front-passenger seat

60/40 split one-touch flip-up rear seat with underseat storage (SuperCrew includes folding armrest with cupholders)

INTERIOR

SiriusXM® with 6-month All Access trial subscription¹

110V/400W AC power outlets (1 on center stack and 1 on back of center console)

4.2" productivity screen in instrument cluster

7 audio system speakers

Auto-dimming rearview mirror

Center console-mounted floor shifter

Fixed rear window with privacy glass and defroster

Floor liners with RAPTOR logo

Leather-wrapped steering wheel with thumb pads, center marker, and audio controls

Metallic door-sill scuff plate inserts with FORD PERFORMANCE lettering

Overhead console-mounted upfitter switches (6)

Unique instrument panel center stack and door-trim appliqué

EXTERIOR

Air extractors in hood and flared front fenders

BoxLink™ with 4 premium locking cleats

Cast-aluminum low-profile running boards

Flared pickup box outers

Heavy-duty front and engine skid plates

Integrated clearance lamps

LED taillamps with black housings

Magnetic-painted bumpers

Magnetic-painted FORD grille insert and surround with black mesh

Quad-beam LED headlamps with black housings

Rear tow hooks

True dual exhaust with Matte Black tips

Unique Magnetic-painted wheel-lip moldings

AVAILABLE FEATURES AND PACKAGES:

MECHANICAL

4.10 front axle with TORSEN® differential

Engine block heater

Trailer brake controller

FORD CO-PILOT360 TECHNOLOGY

360-Degree Camera with Split-View Display²

Adaptive Cruise Control with Stop-and-Go (available in RAPTOR Technology Package)

BLIS® (Blind Spot Information System) with Trailer Coverage and Cross-Traffic Alert²

Lane-Keeping System (available in RAPTOR Technology Package)

Pro Trailer Backup Assist™

Rain-sensing windshield wipers (available in RAPTOR Technology Package)

SEATING

Heated rear outboard seats² (SuperCrew)

INTERIOR

Voice-activated Navigation System with pinch-to-zoom capability, and integrated SiriusXM Traffic and Travel Link® services with 5-year subscription^{1,2}

Inflatable rear safety belts in outboard seating positions² (SuperCrew)

Smoker's Pack with ash cup/coin holder

EXTERIOR

Bed divider²

Bedliner - Plastic drop-in

Bedliner - Tough Bed® spray-in

Front license plate bracket (standard where required)

LED cargo box lighting

Magnetic-painted tailgate appliqué delete

Manual-folding sideview mirrors with power, heated glass, integrated turn signal indicators, high-intensity LED security approach lamps and LED spotlights²

Remote Start System

Stowable bed extender

Stowable loading ramps²

Tailgate step with tailgate lift assist

Tonneau cover - Hard-folding^{2,3}

Tonneau cover - Soft-folding^{2,3}

Toolbox - Aluminum crossbed^{2,3}

Toolbox - Premium aluminum crossbed^{2,3}

Twin-panel moonroof² (SuperCrew)

EQUIPMENT GROUPS

Equipment Group 801A: 10-way power, heated driver and front-passenger seats + cloth-/leather-trimmed seats + power-adjustable pedals + power-sliding rear window with privacy glass and defroster + Magnetic-painted tailgate appliqué with FORD lettering

Equipment Group 802A: includes all content of 801A + 4.10 front axle with TORSEN differential + heated and ventilated front seats with memory driver's seat + 360-Degree Camera + Advanced Security Pack (includes SecuriLock® Passive Anti-Theft System and inclination/intrusion sensors) + Ice Blue® ambient lighting + BLIS (Blind Spot Information System) with Trailer Coverage and Cross-Traffic Alert + dual-zone electronic automatic temperature control + inflatable rear safety belts in outboard seating positions (SuperCrew) + trailer brake controller + LED cargo box lighting + power-adjustable pedals with memory + Intelligent Access with push-button start + power-folding sideview mirrors with power, heated glass, memory, integrated turn signal indicators, high-intensity LED security approach lamps, LED spotlights, driver's side auto-dimming feature, and body-color caps + body-color door and tailgate handles + power-tilt/-telescoping steering column with memory + heated steering wheel + Pro Trailer Backup Assist + Remote Start System + remote tailgate release + B&O Sound System with HD Radio™ Technology + universal garage door opener + voice-activated Navigation System + 8" productivity screen in instrument cluster

PACKAGES

Exterior Graphics Package: box side RAPTOR graphics

Hood Graphics Package

RAPTOR Carbon Fiber Package:² High-Gloss Black carbon-fiber finish on dash, media bin lid, shift knob and door-trim appliqué

RAPTOR Interior Color Accent Package:² aluminum dash panels; High-Gloss Black carbon-fiber finish on dash, media bin lid, shift knob and door-trim appliqué; and Black leather-trimmed RECARO sport seats with blue Alcantara® inserts and blue accent stitching

RAPTOR Technology Package:² Lane-Keeping System, rain-sensing windshield wipers, windshield wiper de-icer, and Adaptive Cruise Control with Stop-and-Go

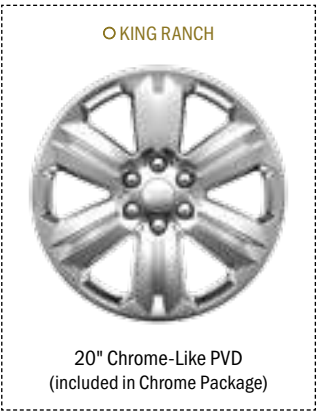

● STANDARD ○ AVAILABLE

TIRES

245/70R17 BSW All-Season (4x2)

● XL, XLT

265/70R17 OWL All-Terrain (4x4)

● XL, XLT

LT245/70R17E BSW All-Terrain¹

○ XL

LT245/70R17E BSW All-Terrain
(Requires FX4 Off-Road Package)

○ XL, XLT

265/60R18 BSW All-Season (4x2)
(Incl. in Chrome and Sport Packages)

○ XLT

265/60R18 BSW All-Season (4x2)

● LARIAT, KING RANCH[®]

275/65R18 OWL (4x4)

(Incl. in Chrome and Sport Packages)

○ XLT

275/65R18 OWL All-Terrain (4x4)

● LARIAT, KING RANCH

LT275/65R18C OWL All-Terrain
(Heavy-Duty Payload Package)

○ XL, XLT

LT275/65R18C OWL All-Terrain¹
(Requires FX4 Off-Road Package)

○ XLT, LARIAT

275/55R20 BSW All-Season (4x2)

● PLATINUM
○ XL, XLT, LARIAT, KING RANCH

275/55R20 BSW All-Terrain¹ (4x4)

● PLATINUM ○ XL, XLT, LARIAT

275/55R20 OWL All-Terrain¹ (4x4)

○ XLT, LARIAT, KING RANCH

275/45R22 BSW All-Season

● LIMITED

LT315/70R17 BSW All-Terrain

● RAPTOR

All-season tires are designed for F-150 load requirements, have excellent traction on paved surfaces, and are optimized for a smooth ride, fuel efficiency, and road noise.

All-terrain tires are designed for F-150 load requirements, have enhanced traction on unpaved surfaces, and are optimized for a smooth ride, fuel efficiency, and road noise.



● STANDARD ○ AVAILABLE

2019 F-150 | ford.com

¹Restrictions may apply. See your dealer for details.



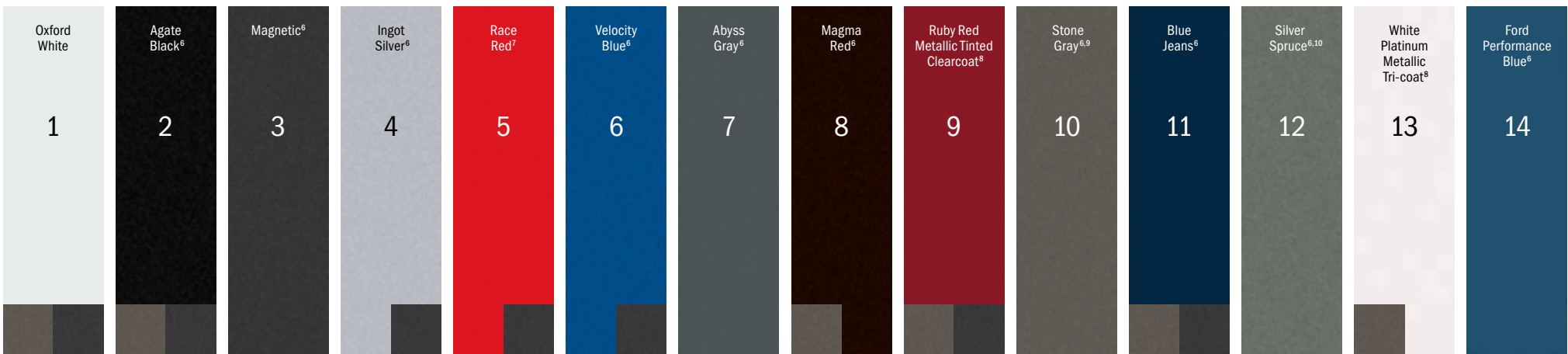
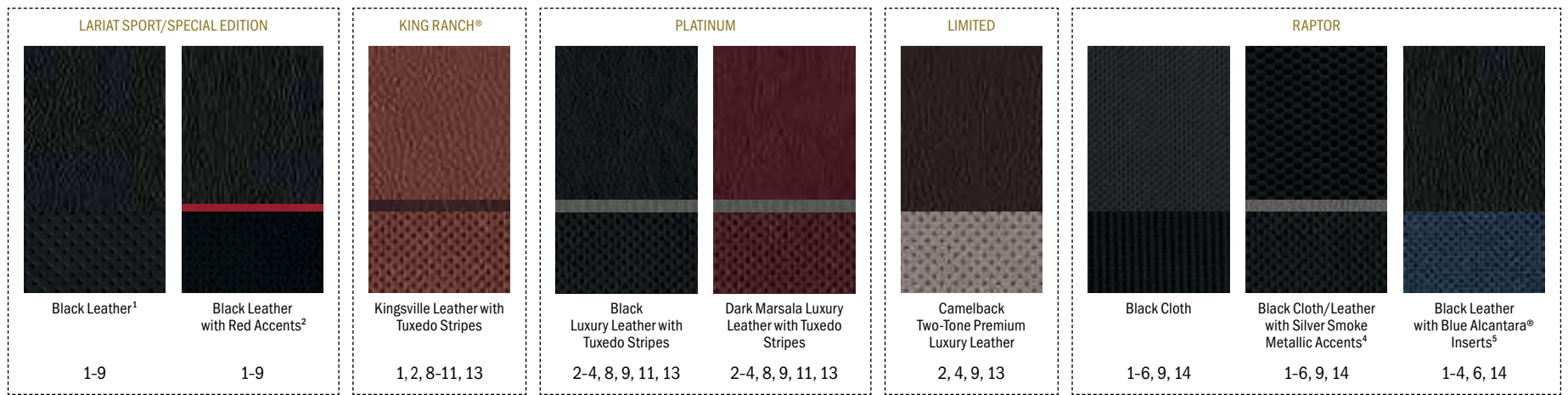
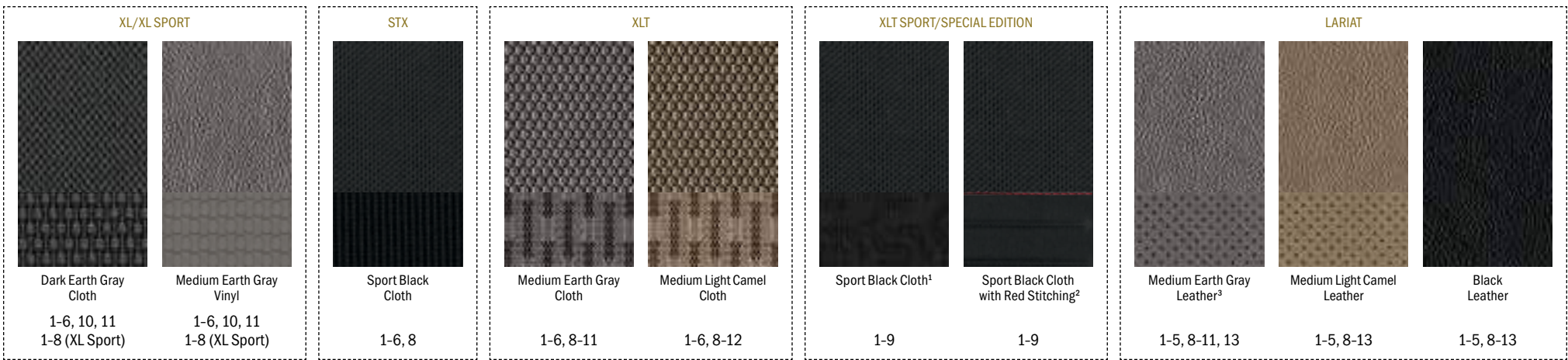

2019 F-150 | ford.com

■ Stone Gray Two-Tone Accent exterior standard on KING RANCH; optional on LARIAT ■ Magnetic Two-Tone Accent exterior optional on XLT

Colors are representative only. See your dealer for actual paint/trim options. ¹Requires Sport Package. ²Requires Special Edition Package. ³Not available with Stone Gray two-tone exterior. ⁴Requires Equipment Group 801A or 802A. ⁵Requires RAPTOR Interior Color Accent Package. ⁶Metallic. ⁷Requires Chrome Package on LARIAT. ⁸Additional charge. ⁹Requires Chrome Package on KING RANCH. ¹⁰Restrictions apply. See your dealer for details.



CONVENTIONAL TOWING

Maximum Loaded Trailer Weight Ratings (lbs.)

Engine	Axle Ratio	GCWR	Regular Cab				SuperCab				SuperCrew®				
			122.4" WB 4x2	4x4	141.1" WB 4x2	4x4	145.0" WB 4x2	4x4	163.7" WB 4x2	4x4	145.0" WB 4x2	4x4	156.8" WB 4x2	4x4	
3.3L Ti-VCT V6 Gas	3.55	9,600/9,700 9,800/9,900 10,000	5,100/- -/- -	-/- 5,000/- -	-/5,100 -/- -	-/- -/- -	-/- -/- -	-/- -/- -	-/- -/- -	-/- -/- -	-/- -/- 5,000	-/- -/- -	-/- -/- -	-/- -/- -	
	3.73	12,200/12,300 12,400/12,500 12,600	7,700/- -/- -	-/7,500 -/- -	-/7,700 -/- -	-/7,400 -/- -	-/7,400 -/- -	-/- -/- -	-/- -/- -	-/- -/- -	-/- 7,400/- -	-/- -/- 7,400	-/- -/- -	-/- -/- -	
2.7L EcoBoost® V6 Gas	3.55	12,300/12,500 12,600/12,700 12,800/12,900	7,600/- -/- -	-/7,600 -/- -	-/7,600 -/- -	-/- 7,600/- -	-/- -/- -	-/- -/- -	-/- 7,500/- -	-/- -/- -	-/- -/- 7,700/-	-/- -/- -/- 7,600	-/- -/- 7,700/-	-/- -/- -	
	3.73	13,200/13,300 13,400/14,100 14,200/14,300	8,500/- -/- -	-/8,400 -/- -	8,500/- 8,500 ¹ /- -	-/8,300 -/- -	-/8,300 -/- -	-/8,000 -/- -	-/8,200 -/- 9,000 ¹ /-	-/- -/- -	-/8,200 -/- -	-/8,000 -/- -	-/8,200 -/- -	-/8,200 -/- -	
5.0L Ti-VCT V8 Gas	3.15	13,100/14,000 14,200/14,300	8,400/- -/- -	-/- -/- -	-/9,200 -/- -	-/- -/- -	-/- 9,200/- -	-/- -/- -	-/- -/- -	-/- -/- -	-/- 9,100/- -	-/- -/- -	-/- 9,100/- -	-/- -/- -	
	3.31	13,100/13,300 14,000/14,200 14,300/14,400	8,400/- -/- -	-/8,300 -/- -	-/- 9,200/- -	-/- -/- -	-/- -/- -	-/- -/- -	-/- -/- -	-/- -/- -	-/- -/- -	-/- -/- -	-/- -/- -	-/- -/- -/- 9,000	
	3.55	13,300/13,900 14,200/14,400 14,500/14,600 15,000/15,200 15,300	-/9,200 -/- -/- -/- -	8,300/- -/- -/- -/- -	-/- -/- -/- -/- -	-/- 9,100/- -/- -/- -	-/- -/- -/- -/- -	-/- -/- -/- -/- -	-/- -/- -/- -/- -	-/- -/- -/- -/- -	-/- -/- -/- -/- -	-/- -/- -/- -/- -	-/- -/- -/- -/- -	-/- -/- -/- -/- -	-/- -/- -/- -/- -
	3.73	14,700/16,000 16,200/16,300 16,600/16,900	-/- -/- -	9,700/- -/- -	-/11,000 ² -/- -	-/- 11,100 ² /11,200 -/-	-/- -/- -	-/- -/- 11,300/-	-/- -/- -	-/- 11,000 ² /- -	-/- 10,700 ² /- 11,200/-	-/- -/- -	-/- -/- -	-/- -/- -	-/- -/- -/- 11,500
	3.55	15,500/15,800 15,900/16,100 16,200/16,700 17,000/17,100 17,900/18,200 18,400	-/- -/- -/- -/- -/- -	-/- -/- -/- -/- -/- -	10,700/- -/- -/- 12,100 ⁴ /- -/- -	-/- 10,800/- -/- -/- -/- -	-/- -/- -/- -/- -/- -	-/- -/- -/- -/- -/- -	-/- -/- -/- -/- -/- -	-/- -/- -/- -/- -/- -	-/- -/- -/- -/- -/- -	-/- -/- -/- -/- -/- -	-/- -/- -/- -/- -/- -	-/- -/- -/- -/- -/- -	-/- -/- -/- -/- -/- -
3.73	17,100	-	-	12,000 ²	11,800 ²	-	-	11,700 ²	11,500 ²	-	-	11,700 ²	11,500 ²		
3.0L Power Stroke® Diesel	3.31	15,700/15,900 16,000/16,100	-/- -/- -	-/- -/- -	-/- -/- -	-/- -/- -	-/- -/- -	10,100/- -/- -	-/- 10,100/- -	-/- -/- -	-/- -/- -	-/10,200 -/- -/- 10,700	-/- -/- -/- 10,700	-/10,100 -/- -/- 11,100	-/- -/- -/- 11,100
	3.55	16,000/16,100 17,100	-/- -/- -	-/- -/- -	-/- -/- -	-/- -/- -	-/- -/- -	-/- 11,500 11,200	10,100/- -/- -	-/- -/- -	-/- -/- -	-/- -/- -	-/10,100 10,900	-/- 11,300	-/10,100 11,100

Best-in-class configuration shown bolded and in color.

2019 F-150 | ford.com

WB = wheelbase ¹Requires 2.7L EcoBoost Payload Package. ²Requires Heavy-Duty Payload Package. ³LIMITED only. ⁴Requires Max. Trailer Tow Package.

Towing Notes: Maximum loaded trailer weights shown. Do not exceed trailer weight of 5,000 lbs. when towing with bumper only. The combined weight of the towing vehicle (including options, hitch, passengers and cargo) and the loaded trailer must not exceed the GCWR (Gross Combination Weight Rating). Trailer tongue load weight should be 10-15% of total loaded trailer weight. Make sure that the vehicle payload (reduced by option weight) will accommodate trailer tongue load weight and the weight of passengers and cargo added to the towing vehicle. The addition of trailer tongue load weight, and the weight of passengers and cargo, cannot cause vehicle weights to exceed the rear GAWR (Gross Axle Weight Rating) or GVWR (Gross Vehicle Weight Rating). These ratings can be found on the vehicle's Safety Compliance Certification Label. See the RV and Trailer Towing Guide for requirements, restrictions and 5th-wheel towing.



PAYLOAD

Maximum Payload Weight Ratings (lbs.)

Engine	Drive	Max. GVWR	Regular Cab		SuperCab		SuperCrew®	
			122.4" WB	141.1" WB	145.0" WB	163.7" WB	145.0" WB	156.8" WB
3.3L Ti-VCT V6 Gas	4x2	6,100	1,990	—	—	—	—	—
		6,170	—	1,960	—	—	—	—
		6,280	—	—	—	—	1,700	—
		6,300	—	—	1,840	—	—	—
		6,390	—	1,920	—	—	—	—
	4x4	6,120	1,730	—	—	—	—	—
		6,390	—	1,920	—	—	—	—
		6,500	—	—	1,770	—	1,680	—
		6,070	1,860	—	—	—	—	—
		6,220	—	1,920	—	—	—	—
2.7L EcoBoost® V6 Gas	4x2	6,360	—	—	—	—	1,710	—
		6,400	—	—	1,840	—	—	—
		6,500	—	—	—	1,800	—	1,820
		6,650	—	—	—	—	1,940 ¹	—
		6,750	—	—	2,120 ¹	—	—	—
	4x4	6,800	—	—	—	—	—	2,060 ¹
		6,900	—	2,470 ¹	—	2,150 ¹	—	—
		6,210	1,720	—	—	—	—	—
		6,500	—	1,920	1,640	—	—	—
		6,600	—	—	—	—	1,690	—
5.0L Ti-VCT V8 Gas	4x2	6,200	1,950	—	—	—	—	—
		6,750	—	2,390	—	—	—	—
		6,800	—	—	—	—	2,140	—
		6,900	—	—	2,320	—	—	—
		6,950	—	—	—	—	—	2,260
	4x4	7,000	—	—	—	2,290	—	—
		7,850	—	3,270²	—	3,070 ²	—	2,930 ²
		6,400	1,840	—	—	—	—	—
		6,950	—	2,320	—	—	—	—
		7,000	—	—	—	2,020	2,080	—
3.5L EcoBoost Gas	4x2	6,750	—	—	—	—	2,050 ³	—
		6,900	—	—	2,260	—	—	—
		7,000	—	—	—	—	—	2,270
		7,050	—	2,640	—	2,250	—	—
		7,850	—	3,230 ²	—	2,950 ²	—	2,870 ²
	4x4	6,750	—	—	—	—	1,280 ⁴	—
		7,000	—	—	—	—	2,050	—
		7,050	—	2,370	2,150	2,050	—	2,050
		7,850	—	3,040 ²	—	2,730 ²	—	2,690 ²
		3,000	—	—	—	—	—	—
3.0L Power Stroke® Diesel	4x2	7,050	—	—	2,020	—	1,980	1,920
	4x4	7,050	—	—	1,760	—	1,720	—
		7,100	—	—	—	—	—	1,720

Best-in-class configuration shown bolded and in color.

DIMENSIONS

	Regular Cab 4x2/4x4	SuperCab 4x2/4x4	SuperCrew 4x2/4x4
Exterior			
Height			
5½' box	—	—	75.6"/77.2"
6½' box	75.5"/76.9"	75.5"/77.2"	75.7"/77.3"
8' box	75.1"/76.9"	75.5"/77.0"	—
Width			
Excl. mirrors	79.9"	79.9"	79.9"
Incl. standard mirrors	96.8"	96.8"	96.8"
Incl. trailer tow mirrors	105.9"	105.9"	105.9"
Std. mirrors folded	83.5"	83.5"	83.5"
Trailer tow mirrors folded	85.5"	85.5"	85.5"
Length			
5½' box	—	—	231.9"
6½' box	209.3"	231.9"	243.7"
8' box	227.9"	250.5"	—
Wheelbase			
5½' box	—	—	145.0"
6½' box	122.4"	145.0"	156.8"
8' box	141.1"	163.7"	—
Ground clearance (min.)			
5½' box	—	—	8.5"/9.4"
6½' box	8.8"/9.4"	8.7"/9.4"	8.4"/9.3"
8' box	8.6"/9.4"	8.7"/9.3"	—
Cargo Box	5½' Box	6½' Box	8' Box
Volume (cu. ft.)	52.8	62.3	77.4
Inside height	21.4"	21.4"	21.4"
Length at floor	67.1"	78.9"	97.6"
Width at wheelhouse	50.6"	50.6"	50.6"
Maximum width at floor	65.2"	65.2"	65.2"
Interior – Front/Rear	Regular Cab	SuperCab	SuperCrew
Head room	40.8"/—	40.8"/40.3"	40.8"/40.4"
Leg room (max.)	43.9"/—	43.9"/33.5"	43.9"/43.6"
Hip room	62.5"/—	62.5"/64.7"	62.5"/64.7"
Shoulder room	66.7"/—	66.7"/65.8"	66.7"/65.9"

MECHANICAL

Front Suspension

Coil-over-shock
Axle rating @ ground: 2,850 lbs.-3,750 lbs.

Rear Suspension

Solid axle
Axle rating @ ground: 3,300 lbs.-4,800 lbs.

Brakes

4-wheel vented-disc with ABS
Front rotor diameter: 13.8"
Rear rotor diameter: 13.7"

RAPTOR

Exterior Dimensions	SuperCab	SuperCrew
Height	78.5"	78.5"
Width		
Excl. mirrors	86.3"	86.3"
Incl. standard mirrors	96.8"	96.8"
Std. mirrors folded	86.3"	86.3"
Length	220.0"	231.9"
Wheelbase	134.2"	146.0"
Ground clearance (min.)	9.9"	9.8"
Approach angle	30.2°	30.2°
Departure angle	23.1°	23.0°
Ramp breakover angle	22.9°	21.8°
Front/rear track	73.9"/73.6"	73.9"/73.6"
Payload & Towing (lbs.)		
Max. GVWR	6,650	7,050
Max. GCWR	12,050	14,250
Max. Payload	1,000	1,200
Max. Towing	6,000	8,000



CAPABILITY PACKAGES

2.7L ECOBOOST® PAYLOAD PACKAGE¹ 3.73 electronic-locking rear axle and 9.75" gearset

○ XL, XLT

CLASS IV TRAILER HITCH (towing capability up to 6,000 lbs. with the 3.3L Ti-VCT V6 and 2.7L EcoBoost engines; towing capability up to 7,000 lbs. with the 3.5L EcoBoost, 5.0L V8, and 3.0L diesel engines): 4-pin/7-pin wiring harness, Class IV trailer hitch receiver, and Smart Trailer Tow Connector

● LARIAT, KING RANCH, PLATINUM, LIMITED ○ XL, XLT

CNG/PROPANE GASEOUS ENGINE PREP PACKAGE¹ (requires 5.0L V8 engine): hardened engine intake valves and valve seats and bi-fuel manifold

○ XL, XLT, LARIAT, KING RANCH

FX4 OFF-ROAD PACKAGE¹ (4x4): 3.31 electronic-locking rear axle (5.0L, 3.5L EcoBoost and 3.0L diesel engines) or 3.55 electronic-locking rear axle (2.7L EcoBoost engine), FX4 Off-Road box decals, Hill Descent Control™ off-road-tuned shock absorbers, floor liners, and skid plates for fuel tank, transfer case and front differential

○ XL, XLT, LARIAT, KING RANCH, PLATINUM

HEAVY-DUTY PAYLOAD PACKAGE¹ (3.3L, 5.0L and 3.5L EcoBoost engines): 3.73 electronic-locking rear axle, 9.75" gearset, 36-gallon fuel tank, upgraded springs, and 18" silver heavy-duty aluminum wheels with LT275/65R18C OWL all-terrain tires

○ XL, XLT

MAX. TRAILER TOW PACKAGE¹ (required for towing up to 13,200 lbs.; requires 3.5L EcoBoost engine): 3.55 electronic-locking rear axle (3.73 with Heavy-Duty Payload Package), 4-pin/7-pin wiring harness, 36-gallon fuel tank, Class IV trailer hitch receiver, Smart Trailer Tow Connector, trailer brake controller, upgraded front stabilizer bar, upgraded rear bumper, and trailer hookup lamp

○ XL

MAX. TRAILER TOW PACKAGE WITH PRO TRAILER BACKUP ASSIST¹ (required for towing up to 13,200 lbs.; requires 3.5L EcoBoost engine): 3.55 electronic-locking rear axle (3.73 with Heavy-Duty Payload Package), 4-pin/7-pin wiring harness, 36-gallon fuel tank, Class IV trailer hitch receiver, Smart Trailer Tow Connector, trailer brake controller, upgraded front stabilizer bar, upgraded rear bumper, trailer hookup lamp, and Pro Trailer Backup Assist™

○ XL, XLT, LARIAT, KING RANCH, PLATINUM

SNOW PLOW PREP PACKAGE¹ (4x4; requires 5.0L V8 engine): preselected springs and snow plow mode with dash-mounted button; electronic shift-on-the-fly (ESOF) transfer case replaces standard 2-speed automatic 4WD transfer case on LARIAT

○ XL, XLT, LARIAT

TRAILER TOW PACKAGE¹ (required for towing up to 11,300 lbs.): 4-pin/7-pin wiring harness, Class IV trailer hitch receiver, Smart Trailer Tow Connector, upgraded front stabilizer bar, and trailer hookup lamp

● RAPTOR ○ XL

TRAILER TOW PACKAGE WITH PRO TRAILER BACKUP ASSIST¹ (required for towing up to 11,300 lbs.): 4-pin/7-pin wiring harness, Class IV trailer hitch receiver, Smart Trailer Tow Connector, upgraded front stabilizer bar, trailer hookup lamp, and Pro Trailer Backup Assist

○ XL, XLT, LARIAT, KING RANCH, PLATINUM, LIMITED



● STANDARD ○ AVAILABLE

2019 F-150 | ford.com

XL SuperCab 4x4. Velocity Blue. STX Package. Available equipment. ¹Restrictions may apply. See your dealer for details.



New Vehicle Limited Warranty. We want your Ford F-150 ownership experience to be the best it can be. Under this warranty, your new vehicle comes with 3-year/36,000-mile bumper-to-bumper coverage, 5-year/60,000-mile Powertrain Warranty coverage, 5-year/60,000-mile safety restraint coverage, and 5-year/unlimited-mile corrosion (perforation) coverage on aluminum body panels – all with no deductible. Please ask your Ford Dealer for a copy of this limited warranty.

Roadside Assistance. Covers your vehicle for 5 years or 60,000 miles, so you have the security of knowing that help may be only a phone call away should you run out of fuel, lock yourself out of the vehicle or need towing. Your Ford Dealer can provide complete details on all of these advantages.

Ford Credit. Get the ride you want. Whether you plan to lease or finance, you'll find the choices that are right for you at Ford Credit. Ask your Ford Dealer for details or check us out at fordcredit.com.

Ford Protect™ Extended Service Plans. Whether you purchase or lease your Ford vehicle, insist on genuine Ford Protect extended service plans. Ford Protect has a variety of plans to give you peace-of-mind protection whether you want vehicle component or maintenance coverage. Plus, they are fully backed by Ford and honored at all Ford dealerships in the U.S., Canada and Mexico. When you visit your dealer, insist on genuine Ford Protect extended service plans.

Insurance Services. Get Ford Motor Company quality in your auto insurance. Our program offers industry-leading benefits and competitive rates. Call 1-877-367-3847, or visit us at fordvip.com for a no-obligation quote. Insurance offered by American Road Services Company (in CA, American Road Insurance Agency), a licensed agency and subsidiary of Ford Motor Company.

Ford Original Accessories. They're warranted for whichever provides you the greatest benefit: 24 months/unlimited mileage, or the remainder of your Bumper-to-Bumper 3-year/36,000-mile New Vehicle Limited Warranty. Ford Licensed Accessories (FLA) are warranted by the accessory manufacturer's warranty. FLA are designed and developed by the accessory manufacturer and have not been designed or tested to Ford Motor Company engineering requirements. Contact your Ford Dealer for details and/or a copy of all limited warranties.

Alcantara is a registered trademark of Alcantara S.p.A., Italy. Amazon, Alexa, Echo and all related logos are trademarks of Amazon.com, Inc. or its affiliates. Android, Android Auto, Google, Google Assistant, Google Maps, Google Play, Waze and logos are trademarks of Google Inc. Apple, Apple CarPlay, Apple Maps, Apple Music, iPhone and Siri are trademarks of Apple Inc., registered in the U.S. and other countries. App Store is a service mark of Apple Inc. BANG & OLUFSEN and B&O are registered trademarks of Bang & Olufsen Group. Licensed by Harman Becker Automotive Systems Manufacturing Kft. All rights reserved. BFGoodrich is a registered trademark of Michelin North America, Inc. FOX Racing Shox is a trademark of Fox Factory, Inc. "HD Radio" and the HD Radio logo are proprietary trademarks of iBiquity Digital Corporation. KICKER® is a registered trademark of Stillwater Designs and Audio, Inc. Kelley Blue Book is a registered trademark of Kelley Blue Book Co., Inc. King Ranch is a registered trademark of King Ranch, Inc. PANDORA, the PANDORA logo, and the Pandora trade dress are trademarks or registered trademarks of Pandora Media, Inc. Used with permission. RECARO is a registered trademark of RECARO Betteiligungs-GmbH. Sirius, XM, SiriusXM and all related marks and logos are trademarks of Sirius XM Radio Inc. Torque-On-Demand® is a registered and active trademark of BorgWarner. TORSSEN is a registered trademark of JTEKT Corporation.

Comparisons based on competitive models (class is Full-Size Pickups under 8,500 lbs. GVWR based on Ford segmentation), publicly available information and Ford certification data at time of release. Vehicles may be shown with optional equipment. Features may be offered only in combination with other options or subject to additional ordering requirements/limitations. Dimensions shown may vary due to optional features and/or production variability. Information is provided on an "as is" basis and could include technical, typographical or other errors. Ford makes no warranties, representations, or guarantees of any kind, express or implied, including but not limited to, accuracy, currency, or completeness, the operation of the information, materials, content, availability, and products. Ford reserves the right to change product specifications, pricing and equipment at any time without incurring obligations. Your Ford Dealer is the best source of the most up-to-date information on Ford vehicles.

ford.com/trucks/f150



XLT SuperCrew® 4x4 in Ingot Silver accessorized with a chrome exhaust tip, premium flat splash guards with stainless steel inserts, step bars, stowable load ramps, spray-in bedliner,¹ hard-folding tonneau cover,² side window deflectors,² fender flares,² rear wheel-well liners, trailer tow mirrors and hood deflector



Rear Seat Entertainment (portable)²

Floor liners



Drop-in bedliner and bed tailgate liner

Remote start systems

Shop the complete collection at accessories.ford.com

¹Factory option. See your dealer for details. ²Ford Licensed Accessory.