

CHRYSLER 300



IMPORTED FROM DETROIT®



DESIGN
4

300S
12

VERSATILITY
16

PERFORMANCE
18

TECHNOLOGY / ENTERTAINMENT
30

SAFETY & SECURITY
40

SPECIFICATIONS
44

CHRYSLER



2019 300

IMPORTED FROM DETROIT®

A close-up, low-angle shot of a dark-colored car's front end. The focus is on the headlight, which features a prominent circular lens and a series of LED light strips along its edge. The car's body panels are highly reflective, showing highlights from the surrounding environment. The background is blurred, suggesting an urban setting with buildings and trees.

POWERFUL DESIGN

MOVES US



CULTURAL

REVOLUTION

THE BEST DESIGNS ARE EMOTIONAL FOREVER.

THE ENDURING ELOQUENCE OF THE CHRYSLER 300 STANDS AS TESTIMONY
TO ATTAINABLE LUXURY IN PERFORMANCE AND STYLE.

Providing advanced connectivity and technologies confirms this icon is built for a modern lifestyle. It assures a perfect balance of power, efficiency and convenience to the lasting beauty of each adaptation. The city for which it stands, the name it stakes claim to and the reward to its drivers: still relevant and revolutionary — even standing still.



The sleek windows, long hood and short trunk give the Chrysler 300 the impression of speed, even when stationary. 7



DETAILS MATTER



Classic design extols the virtues of function and form. Each handsome Chrysler 300 model exhibits premium craftsmanship with available leather interiors and exquisite details in statement-making finishes. Drivers feel the solid framework and seamless flow, while distinctive grilles serve as trophies to the bold shape and admirable platform.



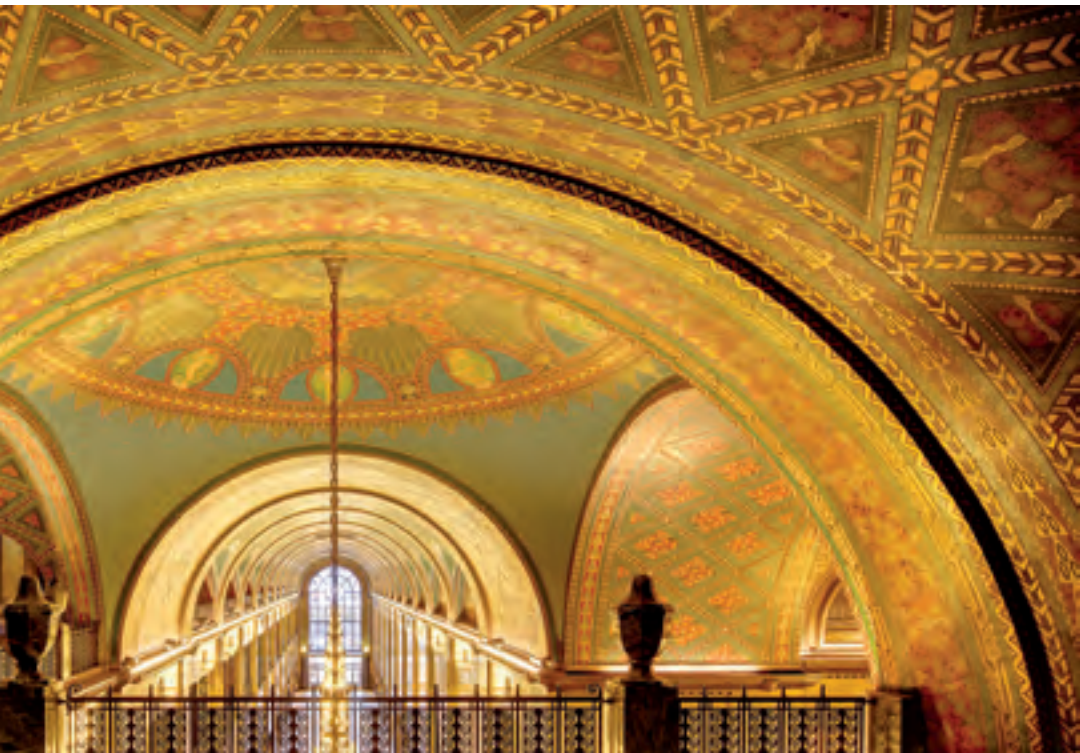

STYLE PERSONIFIED

FROM THE DISTINCTIVE SAPPHIRE-BLUE AMBIENT DISPLAY TO THE INTUITIVE CONTROLS, EVERY DETAIL OF THE CHRYSLER 300 IS AN ENDEAVOR IN REFINED SHAPE AND OPTICS.

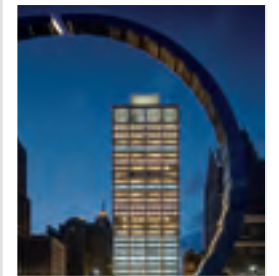

GAUGE YOUR PREFERENCES

The leather-wrapped and available heated steering wheel provides an advanced ergonomic grip, cruise settings, hands-free^{1*} phone controls and available performance-driving Sport mode paddle shifters. The three-spoke design invites a clear view to the gauges and 7-inch Driver Information Display (DID). An available two-tone premium Nappa leather-wrapped, stitched and real-wood steering wheel with a tilt / telescoping column adds a layer of luxury you can feel.

¹A note about this brochure: all disclaimers and disclosures can be found on page 60. 11

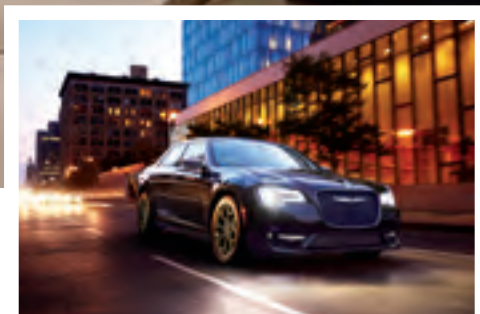

300S: A STATEMENT

TO LIVE BY

S FACTOR

The 300S gives drivers an edge when it comes to approach. Black headlamp and fog lamp bezels, LED taillamps, Black Chrome surround grille, Gloss Black window trim and new 20-inch Black Noise wheels on Rear-Wheel-Drive models offer an imposing statement. The demeanor extends inside, with available premium, perforated leather-trimmed performance seats with high-bolstered contours in suede, providing more lateral support during spirited driving.

Thanks to this model's dual-exhaust accompanying the standard 3.6L Pentastar® V6 engine and 8-speed transmission, 300S produces an astounding 300 horsepower and 264 lb-ft of torque. Combined with Sport mode dynamics and a performance-tuned suspension, the strut is much more than surface.





SHAPE THAT STAYS TRUE TO FORM

The legendary 300 remains renowned for its strength and stunning shape. The uniquely square, chiseled face features premium applications representing the brilliance of its architecture and engineering. Framing the signature lighting, wing badge and grille designs, the fascia hardware complements the visual continuity that is undeniably Chrysler.

YOUR VEHICLE IS AN EXTENSION OF YOUR LIFESTYLE.

OPEN AND AIRY

An available dual-pane panoramic sunroof, which extends to the backseat, offers a skylight vibe, while the available power backlight sunshade blocks any unwanted direct sunlight from overhead.





URBAN

RENEWAL



BEST-IN-CLASS² INTERIOR SPACE – MAKES ROOM FOR LIVING LOCAL

Whether sharing your commute, making it a family car or bringing friends on excursions, the best-in-class² passenger volume, with seating for five, gives everyone plenty of space of their own. Rear-seat passengers will enjoy amenities like cup holders, A/C vents and available heated seats, as well as access to USB ports and ergonomically designed seats, including child seat anchors. The 60/40 split rear bench seat offers versatility for travel and those weekend shopping hauls.





5.7L HEMI[®] V8

AUTOMATIC ACCELERATION

There's a reason some prefer to take the lead on the road, and the most powerful V8 available in its class² with the available 5.7L HEMI[®] V8 engine, gets it. Available on 300S Rear-Wheel-Drive models and standard on 300C, the best-in-class² 363 heavyweight V8 horsepower and the surprising punch of 394 lb-ft of torque add up to acceleration that meets the demands of the get-ahead driver.

BEST-IN-CLASS² AVAILABLE V8 HORSEPOWER AND TORQUE

363^{HP}



Like the acclaimed Pentastar® V6 engine, Detroit's Fisher building stands as a hallmark of invention and industrial revolution.



30 MPG*

IMPRESSIVE HIGHWAY FUEL ECONOMY

The Pentastar® V6 with 8-speed transmission delivers a standard 292 horsepower and 260 lb-ft of torque on Touring, Touring L and Limited, while the 300S provides 300 hp and 264 lb-ft of torque. All provide an exceptional blend of fuel efficiency, low emissions and first-rate noise, vibration and harshness control, along with up to an EPA-estimated 19 city/30 hwy mpg.*

**Based on EPA-estimated 19 city/30 hwy mpg 3.6L V6 RWD and 18 city/27 hwy mpg 3.6L V6 AWD. Actual mileage may vary.* 21



RIGHT of WAY

For those who prefer to be in control at every turn, the available Sport mode adds manual shifting to help maximize a dynamic experience. Each gear responds quickly during acceleration with smooth power delivery and transitions. This allows drivers to navigate via steering-wheel-mounted paddle shifters or opt to let the automatic transmission shift normally without driver input.

When in Sport mode, paddle shifters can be used to shift gears as the Electric Power Steering (EPS) Sport Performance is activated. An advanced EPS offers Normal, Comfort and Sport modes for more responsive steering and spirited driving feedback and precision ease when parking.

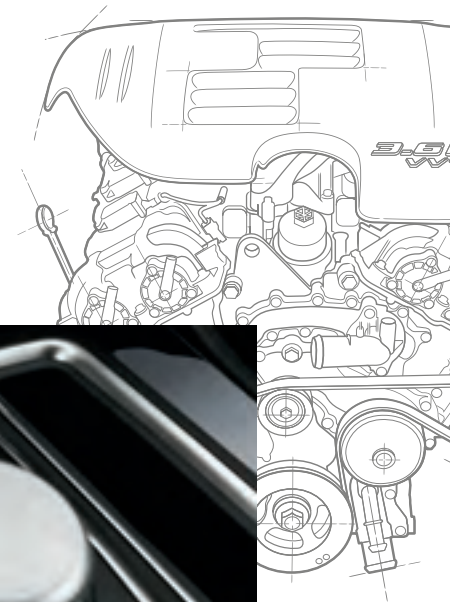

APPLY THE SPORT DYNAMICS

The Sport mode standard on 300S and 300C delivers enhanced steering and throttle feedback, stability control and transmission shifts, and more aggressive available All-Wheel-Drive (AWD) performance.

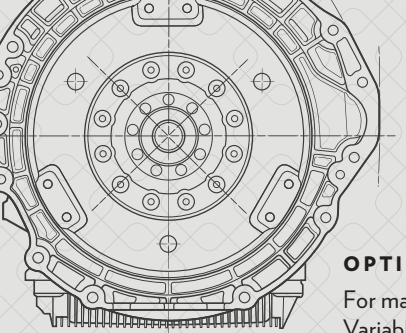

OPTIMUM PERFORMANCE / PRECISION VELOCITY

For maximum power, the legendary available 5.7L HEMI® V8 Variable Valve Timing (VVT) engine with Fuel Saver Technology delivers the power of a V8 with the efficiency of a 4-cylinder engine. Fuel Saver Technology detects when full power isn't needed, like when highway cruising, and deactivates four of the eight cylinders to improve efficiency.



CLASS-EXCLUSIVE² ROTARY E-SHIFTER

The class-exclusive² standard Satin Chrome-finished rotary e-shifter, located on the integrated center console, electronically selects the 8-speed transmission's gears for a smooth, lightweight automatic shift experience.

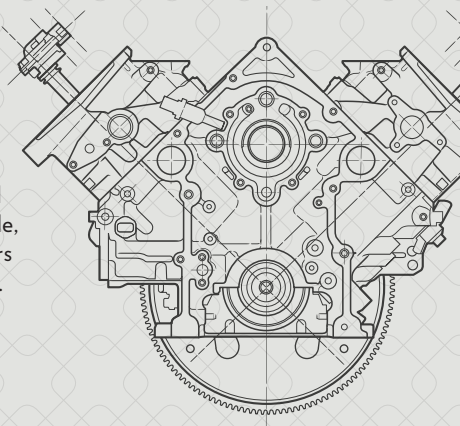



ALL-SEASONS

HANDLING



Optimally tuned multilink suspension, premium shock absorbers and a rear stabilizer bar deliver calibrated road-surface handling during cornering and over bumps.

ADVANCED ALL-WHEEL-DRIVE (AWD) SYSTEM

The available advanced AWD system detects wheel-slip and kicks in before you even realize you need it by automatically distributing power between front and rear wheels. The system also engages when the driver turns off the Electronic Stability Control (ESC)³ system or when the steering wheel paddle shifters are in use. In cases of inclement weather, AWD is tuned to minimize oversteer and maximize traction where snow, ice, mud, sand or gravel is present.



The Electric Power Steering system contributes to increased fuel efficiency while providing exceptional feel and feedback.



TRACTION CAPABILITY WITH FUEL EFFICIENCY

In addition to the ultimate traction performance of AWD, the available system optimizes fuel efficiency by automatically removing front-wheel power when Rear-Wheel Drive is sufficient, such as on dry road surfaces. The appropriate mode engages depending on driving conditions, providing the ultimate in driver convenience as well.

4-WHEEL INDEPENDENT SUSPENSION

Drivers will immediately notice the superior driving dynamics and premium ride and comfort, even on not-so-smooth roads. Multiple bushings designed with first-rate construction materials help reduce road noise, vibration and harshness (NVH) for a smooth, quiet ride.



EXCLUSIVE

QUARTERS

CRUISING PERKS

The 300C interior offers rich, deep-quilted Nappa leather-trimmed seats with accent stitching and quilted door bolsters, as well as heated front and rear seats, and available ventilated front seats. Matte-finish Mocha real wood adds warm accents along with a heated, leather-wrapped steering wheel and leather-wrapped dash. The standard Remote Start⁴ allows the driver's heated seat to be programmed to automatically activate if outside temps are below 40°F, while cooling ventilation activates above 80°F.

YOUR PERSONAL

HOT SPOT⁸

Available Uconnect® 4G LTE makes securing the perfect location to get online simple with a built-in hotspot⁸ that connects to your personal Wi-Fi⁸ account. And with the AT&T® nationwide network, you're always connected to fast, reliable Internet speed for up to eight devices — and within 50 feet of your vehicle.

Uconnect Phone. Pair a Bluetooth® phone to send and receive hands-free¹ calls. Includes Do Not Disturb to route incoming calls to voice mail, hold texts and send automated replies.

Voice Recognition. Make calls, record voice memos and select media stations and navigation destinations.

Drag and Drop Menu Bar. Personalize the touchscreen dashboard with your top six features and services.

One-step Navigation. Uconnect 4C NAV with 8.4-inch touchscreen includes navigation with enhanced graphics, 3D city and landmark images, maps and one-step voice destination. Available.

Climate. Control cabin climate, heated and ventilated seats and steering wheel settings via the 8.4-inch touchscreen and voice activation.

SiriusXM® Audio⁹ Get over 160 channels on your radio, including premium programming and Instant Replay to pause, replay, rewind and fast-forward programs. 1-year trial.

SiriusXM Traffic Plus⁹ / SiriusXM Travel Link⁹ Get detailed information on traffic, construction, road closures, weather forecasts, fuel prices, sports scores and movie schedules.

SiriusXM Guardian™10 A premium suite of safety and convenience services accessed in-vehicle or the Uconnect App, such as SOS call,¹¹ Roadside Assistance Call,¹² Remote Vehicle Start,⁴ Vehicle Finder¹³ and Stolen Vehicle Assistance.¹⁴ Includes a 1-year trial. Available.

APPLE CARPLAY™5

Integrates your iPhone® and Siri®6 voice control with the Uconnect® touchscreen to make calls, access music, send / receive messages and get traffic-optimized directions while focused on the road.

ANDROID AUTO™7

Automatically connects your Android™ phone to the Uconnect touchscreen system to safely access Google Maps and Music, place phone calls, send / receive messages and Google Search by voice.





GET INTO THE
GROOVE

APPLE® TECHNOLOGY The user experience people know and love is now available in the Chrysler 300 for the ultimate in-car entertainment. Use Maps, make phone calls, talk to text and listen to Apple Music — all through your Uconnect® system, Apple CarPlay™5 and available Alpine® Audio Group.

INTRODUCING

The available Apple® experience in the Chrysler 300 offers the ultimate in communication and entertainment connection.

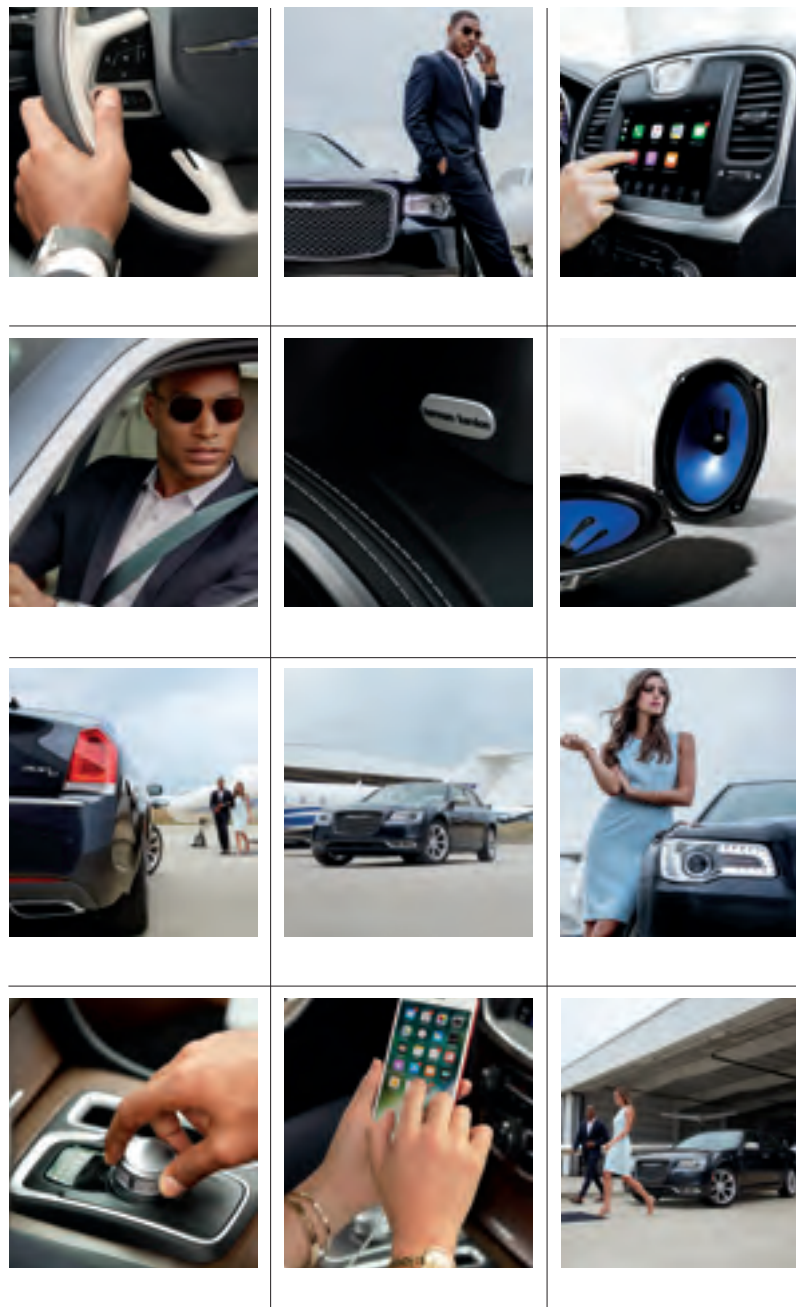



The Harman Kardon® premium audio system, available on 300 Limited and 300C, gives a powerful and perfectly tuned audio experience. The 19-speaker multichannel Surround Sound immerses you and your passengers in optimum music playback realism.



harman/kardon®



Centrally located control buttons on the steering wheel provide first-hand operation for audio, voice and speed controls. Personalize the stats you want to see with the full-color 7-inch Driver Information Display (DID) seamlessly integrated with the instrument cluster. The digital graphics offer a vast range of settings, including audio, speed, compass, temperature, fuel economy, trip, cruise control, vehicle status and engine performance, enabling up to 7,000 available driver configurations.

EVERY INCH EXUDES BEAUTY AND FUNCTION.





EXCLUSIVE PERFORMANCE

APPEARANCE

FEATURED ATTRACTION

For a more athletic attitude that demands being noticed, the 300S V8 includes the S Model Appearance Package, which adds a more aggressive front fascia, unique LED fog lamps, sculpted side sills and deck lid spoiler.



A PERFECT MATCH

Presenting your best self includes showing your refined taste. The available leather-trimmed and accent-stitched seating, instrument panel, doors and center console, real-wood accents, heated and cooled front-console cup holder and generous leg and head room reveal the level of sophistication for you and your passengers' ergonomic pleasure. The driver and front-passenger seats have two heat settings and may be ventilated for faster cooling in warmer weather.



TECHNOLOGIES THAT EXPAND YOUR

SAFEKEEPING



LED Visual Reinforcements. LED taillamps and brake, stop and running lights ensure a consistent and distinct illumination output to rear traffic. Available LED fog lamps provide improved visibility during inclement weather without obstructing the view of oncoming traffic.



Blind Spot Monitoring¹⁵ This available system sees where you can't. It monitors rear blind zones on either side of your vehicle via radar to alert you of vehicles in close proximity. Includes Rear Cross-Path Detection¹⁶ to alert you of vehicles and objects in your path when driving in Reverse.



Available Full-Speed Forward Collision Warning / Active Braking¹⁷ Detects whether your vehicle is approaching another vehicle or large obstacle too rapidly, warning and assisting the driver in avoiding a potential impact.

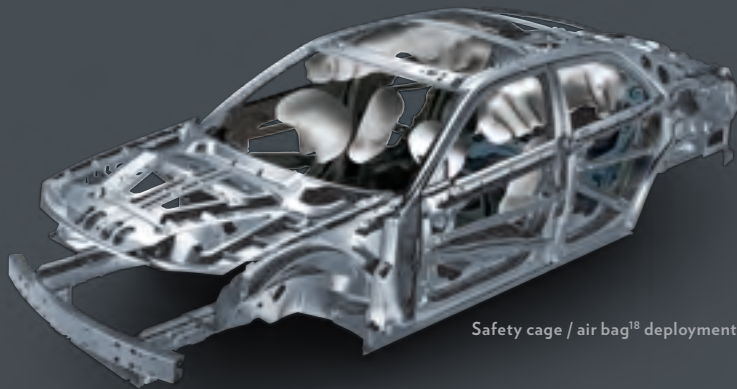

Safety cage / air bag¹⁸ deployment

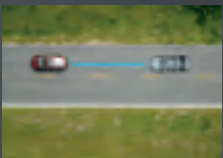

Available Adaptive Cruise Control with Stop¹⁹ Identifies forward-path vehicles to help maintain a set distance at cruising speeds. It maintains one of four preset distances between 0 mph and highway speeds, braking momentarily, then requiring the driver to manually apply brakes.



Available LaneSense[®] Lane Departure Warning / Lane Keep Assist²⁰ Determines vehicle position within lane lines, displaying a cluster warning if you cross either line without using a turn signal. The system automatically aligns to the proper position if the drift is not driver-corrected.



Available ParkSense[®] Front and Rear Park Assist¹⁶ The system alerts you with a chime if your vehicle is too close to another vehicle or object, such as a building, bike or parking meter. A visual reference is also provided in the cluster display for enhanced parking convenience.

80+

STANDARD AND AVAILABLE SAFETY & SECURITY FEATURES



7
AIR BAGS¹⁸
STANDARD

Equipped to protect. The standard air bags¹⁸ include front dual-stage air bags¹⁸ with adaptive venting technology, driver knee air bag,¹⁸ supplemental front-seat-mounted side-impact air bags¹⁸ and side-curtain air bags¹⁸, which extend over front- and rear- outside seating rows. The advanced multistage front air bags¹⁸ deliver varying levels of deployment based on occupant size and impact severity.

CHRYSLER 300 WHEELS



17-inch Cast-Aluminum
Premium Painted Wheel
Standard on 300 Touring
(WF6)



18-inch Cast-Aluminum
Wheel Fully Polished
Standard on 300 Touring L
Optional on 300 Touring
(WPC)



19-inch Cast-Aluminum
Wheel Fully Polished
Standard on 300 Touring AWD,
Touring L AWD and Limited AWD
(WPY)



19-inch Cast-Aluminum
Wheel Fully Painted Black Noise
Standard on 300S AWD
Optional on Touring
(WAK)



19-inch Cast-Aluminum
Wheel Fully Painted Dark Bronze
Optional on 300S AWD
(WAD)



20-inch Cast-Aluminum
Wheel Fully Painted Black Noise
Standard on 300S
Optional on 300 Touring
(WST)



20-inch Cast-Aluminum
Wheel Fully Painted Dark Bronze
Optional on 300S RWD
(WAC)

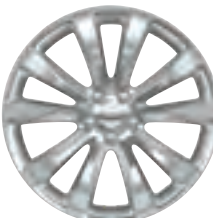

20-inch Cast-Aluminum
Wheel Fully Polished
Standard on 300 Limited
Optional on 300 Touring
and Touring L
(Wfy)



20-inch Cast-Aluminum
Wheel Fully Polished with Satin Clear
Standard on 300C
(WDE)



CHRYSLER 300 COLORS

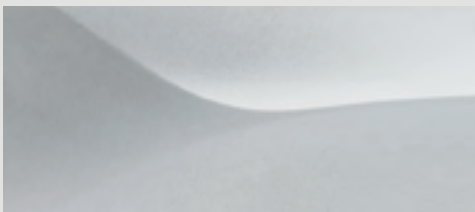

Silver Mist



Granite Crystal



Bright White

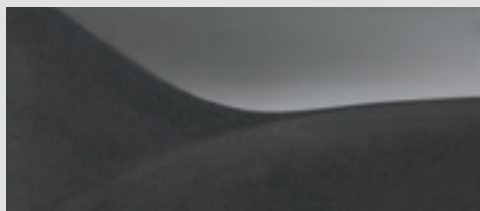

Ceramic Grey

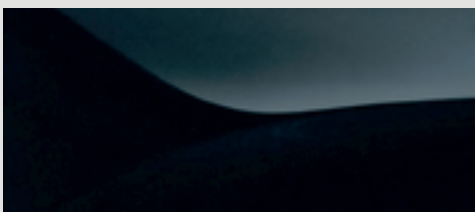

Maximum Steel

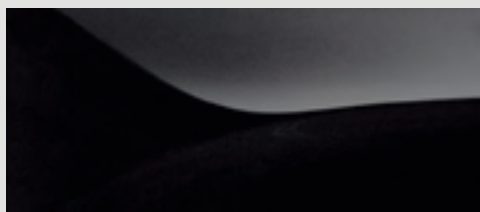

Gloss Black

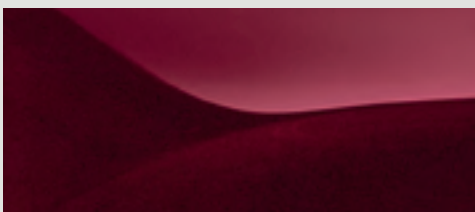

Velvet Red Pearl Coat



Ocean Blue



CHRYSLER 300 MATERIALS



Black Cloth
Standard on 300 Touring



Linen Cloth
Standard on 300 Touring



Black Nappa Leather Trim
Standard on 300 Touring L

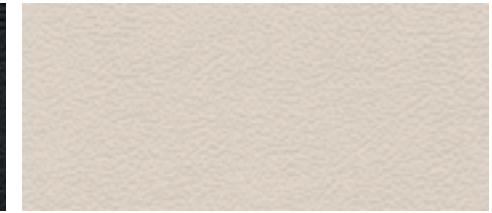

Linen Nappa Leather Trim
Standard on 300 Touring L



Black Nappa Leather Trim with embroidered logo
Standard on 300S

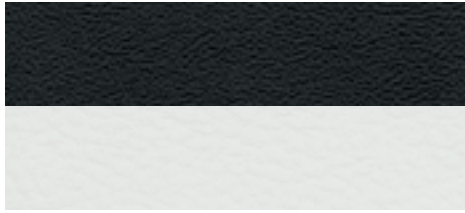

Black / Smoke Nappa Leather Trim with embroidered logo
Standard on 300S



Black Nappa Leather Trim with Caramel accent stitching
and embroidered logo
Packaged with Alloy Edition on 300S



Black Nappa Leather Trim with Axis II perforated insert
and embroidered logo
Packaged with 300S Premium Group 2



Black / Smoke Nappa Leather Trim with Axis II
perforated insert and embroidered logo
Packaged with 300S Premium Group 2



Black Nappa Leather Trim with Alcantara® suede bolsters,
Alcantara perforated suede insert and embroidered logo
Optional on 300S

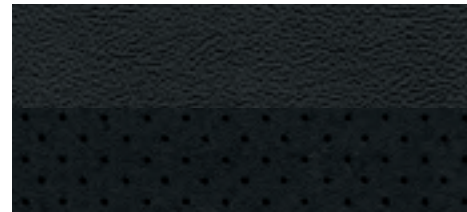

Black Nappa Leather Trim with Axis II perforated insert
Standard on 300 Limited

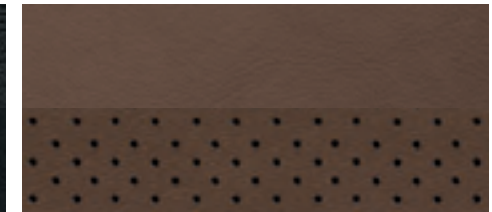

Deep Mocha Nappa Leather Trim with Axis II
perforated insert
Standard on 300 Limited

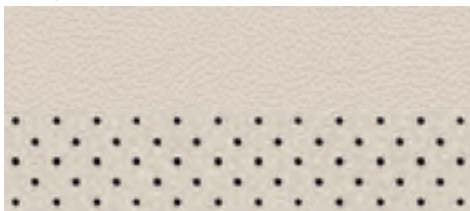

Linen Nappa Leather Trim with Axis II perforated insert
Standard on 300 Limited

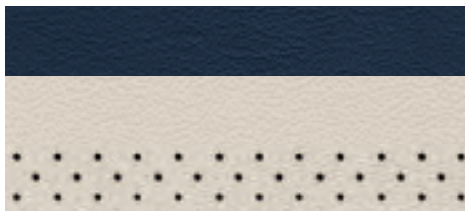

Premium Indigo / Linen Nappa Leather Trim with Axis II
perforated insert
Standard on 300C



Premium Black Nappa Leather Trim with Axis II
perforated insert
Standard on 300C

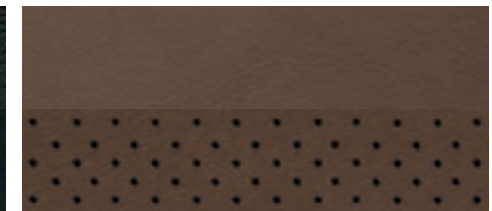

Premium Deep Mocha Nappa Leather Trim with Axis II
perforated insert
Standard on 300C



CHRYSLER 300 SPECIFICATIONS

	300 TOURING	300 TOURING L	300S	300 LIMITED	300C
ENGINES AND TRANSMISSIONS					
3.6L Pentastar® V6 Variable Valve Timing (VVT) with 8-speed Automatic Transmission	•	•	•	•	•
5.7L HEMI® V8 VVT with Multi-Displacement System (MDS) Fuel Saver Technology and interactive Deceleration Fuel Shut-Off (iDFO) with 8-speed Automatic Transmission			○		•
MECHANICAL FEATURES					
All-Wheel Drive (AWD) with Front-Axle Disconnect (includes 3.6L V6)	○	○	○	○	○
Alternators — 160-amp	•	•			
— 180-amp			•	•	•
Battery — 730-amp, maintenance-free	•	•	•	•	•
Brakes — 4-wheel antilock disc with vented front and solid rear discs (includes All-Speed Traction Control)	•	•	•	•	•
— Performance (packaged with 5.7L HEMI engine and AWD)	p	p	p	p	•
Engine Block Heater	○	○	○	○	○
Exhaust System — Dual-exhaust with bright tips	•	•	•	•	•
— Titanium tips (included with Alloy Edition)			p		
Fuel Tank — 18.5-gallon	•	•	•	•	•
Fuel-Filler System — Capless, with remote fuel-door release	•	•	•	•	•
Remote Keyless Enter 'n Go™ — Proximity entry and push-button ignition system	•	•	•	•	•
Speed Control	•	•	•	•	•
— Adaptive Cruise Control with Stop ¹⁹ (included with SafetyTec™ Plus Group)			p	p	p
Sport Mode — Selectable Sport-tuned transmission shift points (includes steering-wheel-mounted shift controls; included with 5.7L HEMI V8 engine)			•		•
Steering — Electric	•	•	•	•	•
Suspension — 4-wheel independent AWD	○	○	○	○	
— 4-wheel independent comfort	○	○			
— 4-wheel independent touring	•	•		•	•
— 4-wheel independent performance			•		
Tip Start System	•	•	•	•	•
EXTERIOR FEATURES					
Badging — 300 Limited — Chrome finish	•	•		•	
— 300S — Black finish			•		
— 300C					•
— Dark Bronze (packaged with 300S Alloy Edition)			p		
— AWD	p	p	p	p	
— Rear, Chrysler wing badge	•	•		•	•
— Wing badge with Black accent (packaged with Sport Appearance Package)	p		•		
— Chrysler badge (packaged with Chrome Appearance Package)	p	•	•	•	•
— Wing badge with Liquid Titanium Chrome (packaged with 300S Alloy Edition)			p		
Cladding — Lower bodyside	•	•	•	•	•
Door Handles — Body-color	•	•	•		
— Bright					•
— Platinum					•
Glass — Acoustic windshield and front doors; Solar-Control front and rear windows	•	•	•	•	•
Grille — Black with Black Chrome surround (packaged with Sport Appearance Package)	p		•		
— Black with bright surround	•	•			
— Platinum Grille with Platinum surround (packaged with Chrome Appearance Package)	p				•
— Granite Crystal with Chrome surround					•
— Dark Bronze grille and surround (packaged with Alloy Edition)			p		
Headlamps — Adaptive Bi-xenon High Intensity Discharge (HID) with delay and automatic leveling system (included with 300S Premium Group 2 and Light Group)			p	p	•
— LED daytime running lamps	•	•	•	•	•
— Auto High-Beam Headlamp Control (included with SafetyTec Plus Group)			p	p	p

• = Standard ○ = Optional P = Available within package

EXTERIOR FEATURES (CONTINUED)

— Automatic	•	•	•	•	•
— Bifunctional halogen projector with delay (not available with adaptive Bi-xenon HID)	•	•	•	•	•
— Black bezels (packaged with Sport Appearance Package)	p		•		
— Chrome bezels	•	•		•	•
— LED fog lamps (included with Value Package, Driver Convenience Group and 300 Premium Group)	p	p	•	•	•
— Premium SRT® fog lamps (included with S Model Appearance Package)			p		
Mirrors — Auto tilt-down adjust when in Reverse (included with 300S Premium Group and 300S Premium Group 2)			p	•	•
— Blind Spot Monitoring (BSM) ¹⁵ and Rear Cross-Path Detection ¹⁶ (included with 300 Premium Group, 300S Premium Group, 300S Premium Group 2 and SafetyTec™ Plus Group)		p	p	p	p
— Body-color	•	•	•		
— Chrome				•	
— Courtesy lamp (driver/passenger; included with 300 Premium Group and 300S Premium Group 2)		p	p	p	p
— E-Chromic auto-dimming (driver's side only; included with 300 Premium Group and 300S Premium Group 2)		p	p	•	•
— Memory (driver's seat, power pedals, power tilt/telescoping steering wheel, exterior mirrors and radio; included with 300S Premium Group 2)			p	•	•
— Platinum					•
— Power/manual foldaway, heated	•	•	•		
— Power/multifunction manual foldaway				•	•
— Supplemental turn signal (driver-/passenger-side; a feature of the power multifunction mirror, included with 300 Premium Group and 300S Premium Group 2)		p	p	p	p
Tires — P225/60R18 BSW Touring	○	•			
— P215/65R17 Low-Rolling Resistance	•				
— P235/55R19 BSW All-Season (optional with All-Wheel Drive (AWD))	○	○			
— P235/55R19 BSW All-Season Performance (included with AWD)	p	p	p	p	
— P245/45R20 BSW All-Season Performance (included with 20-inch wheels)	p	p	•	•	•
— P245/45R20 BSW Performance				○	
— Compact spare	•	•	•	•	•
Wheels — 18-inch polished aluminum	p	•			
— 17-inch premium painted aluminum	•				
— 19-inch Black Noise painted aluminum (included with AWD)				p	
— 19-inch polished aluminum (included with AWD)	p	p		p	
— 19-inch painted Dark Bronze aluminum (included with AWD Alloy Edition)				p	
— 20-inch Black Noise painted aluminum (packaged with Sport Appearance Package)	p		•		
— 20-inch polished aluminum (included with Chrome Appearance Package)	p	○		•	
— 20-inch polished aluminum					•
— 20-inch painted Dark Bronze aluminum (included with Rear-Wheel Drive (RWD) Alloy Edition)				p	
Windows — Power, with driver and front-passenger 1-touch auto up/down and anti-pinch feature	•	•	•	•	•
Wipers — 2-speed variable/intermittent	•	•	•	•	•
— Rain-sensing (included with SafetyTec Plus Group)			p	p	p
INTERIOR FEATURES					
Air Conditioning — Dual-Zone Automatic Temperature Control with humidity sensor	•	•	•	•	•
Air Filtration — Particulate air filter	•	•	•	•	•
Defroster — Rear window	•	•	•	•	•
Door Locks — Power, speed-sensitive; child-protection rear	•	•	•	•	•
Floor Mats — Front and rear	•	•	•	•	•
— Alloy Edition front and rear (included with Alloy Edition)			p		
— Luxury front and rear					•

CHRYSLER 300 SPECIFICATIONS (continued)

INTERIOR FEATURES (CONTINUED)	300 TOURING	300 TOURINGL	300S	300 LIMITED	300C
Interior Accents — Charcoal Wood Hydrographic	•	•			
— Piano Black/Satin Chrome			•		
— Real Black Olive Ash Burl wood				•	
— Real natural-pore Mocha wood					•
— Piano Black bezels			•		
— Satin Chrome bezels	•	•		•	•
Lighting — Glove box, trunk, front reading and map lamps, rear reading and courtesy lamps	•	•	•	•	•
— LED driver and front-passenger lower front footwell lamps (included with 300S Premium Group 2)			p	•	•
— LED-illuminated front and rear map pockets (included with 300S Premium Group 2)			p	•	•
— LED-illuminated front cup holders	•	•	•	•	•
— LED-illuminated rear cup holders		•	•	•	•
Memory System — Memory settings for 2 drivers for the driver's seat, power steering column (when equipped), exterior mirrors and radio (included with power multifunction mirror on 300S Premium Group 2 on 300S)			p	•	•
Mirrors — Rearview, auto-dimming	•	•	•	•	•
— Visor vanity, illuminated, driver and passenger sides	•	•	•	•	•
Passenger Assist Handles — Front, with illuminated rear assist handles	•	•	•	•	•
Pedals — Non-adjustable	•	•	•	•	•
Power Accessory — 12-volt power outlets in center-front instrument panel, center console and back of center console, with delay feature	•	•	•	•	•
Power Backlight Sunshade (included with 300S Premium Group 2)			p	o	o
Seats — 8-way power driver seat with 4-way power lumbar adjuster	•				
— Heated front (included with leather-trimmed bucket seats; not included with cloth seats)		•	•	•	•
— Heated 2nd-row (included with 300S Premium Group 2)			p	•	•
— Cloth bucket seats	•				
— Nappa and suede perforated leather-trimmed performance bucket seats				o	
— Nappa leather-trimmed bucket seats		•			
— Nappa leather-trimmed sport bucket seats			•		
— Nappa leather-trimmed sport bucket seats with perforated inserts and accent stitching (included with 300S Premium Group 2)			p		
— Nappa luxury perforated and quilted leather-trimmed bucket seats					•
— Nappa perforated leather-trimmed bucket seats				•	
— Premium leather interior trim: Poltrona premium leather-wrapped for the instrument panel, cluster brow, door upper and center-console side panels					o
— Rear 60/40 split-folding rear bench seat with armrest and cup holders	•				
— Rear 60/40 split-folding rear bench seat with armrest, cup holders and storage		•	•	•	•
— Ventilated front seats (included with Nappa leather-trimmed sport bucket seats and Nappa and suede perforated leather-trimmed performance bucket seats on 300S)			p	•	•
Shift Knob — Rotary	•	•	•	•	•
Speedometer — 140-mph	•	•	•	•	•
— 160-mph (included with 5.7L HEMI® V8 engine)			p		•
Steering Column — Manual tilt/telescoping	•	•	•	•	•
— Power tilt/telescoping with memory (included with 300S Premium Group 2)			p	•	•
Steering Wheel — Heated (included with 300S Premium Group 2)			p	•	•
— Leather-wrapped	•	•	•	•	•
— Steering-wheel-mounted audio controls	•	•	•	•	•
— Steering-wheel-mounted paddle shifters (included with 5.7L HEMI V8 engine)			•	•	•

• = Standard O = Optional P = Available within package

INTERIOR FEATURES (CONTINUED)

— Wood/leather-wrapped					•
— Luxury					•
Sunroof — Dual-pane panoramic full-power front and fixed rear, with 1-touch open/close feature (included with 300S Premium Group, Value Package, and Sun, Sound and NAV Package)		O/P	O/P	O	O
Temperature Display — Outside reading, with compass	•	•	•	•	•
UCONNECT*					
Audio Systems — 19 premium speakers, with subwoofer and 900-watt amplifier (included with Harman Kardon® Audio Group and Sun, Sound and NAV Package)				O	O
— 6 premium speakers with 276-watt digital amplifier			•	•	•
— 6 speakers	•	•			
— 9 amplified speakers with a subwoofer (included with Alpine® Audio Group with a subwoofer and 300 Premium Group)		p	p		
— Uconnect® 4C with 8.4-inch display — AM/FM/HD radio system with Apple CarPlay™ ⁵ and Android Auto™ ⁷ SiriusXM® Radio ⁹ with 1-year trial included, Integrated Voice Command with Bluetooth® 8.4-inch touchscreen for displaying music, climate controls and vehicle information, Bluetooth and Bluetooth Streaming Audio and Media Hub with audio jack and 2 USB ports	•	•	•	•	•
— Uconnect® 4C NAV with 8.4-inch display and Navigation — AM/FM/HD radio system with Apple CarPlay™ ⁵ and Android Auto™ ⁷ SiriusXM Radio ⁹ with 1-year trial included, SiriusXM Traffic ⁹ and SiriusXM Travel Link ⁹ (includes 5-year trial subscription), Integrated Voice Command with Bluetooth, 8.4-inch touchscreen for displaying music, climate controls and vehicle information, Bluetooth and Bluetooth Streaming Audio and Media Hub with audio jack and 2 USB ports (included with Value Package, Driver Convenience Group, 300 Premium Group, 300S Premium Group, and Sun, Sound and NAV Package)	p	O/P	O/P	O	O/P
Integrated Voice Command with Bluetooth — Includes hands-free ¹ calling and Bluetooth Streaming Audio	•	•	•	•	•
SiriusXM Guardian™ ¹⁰ with 1-year trial subscription included	•	•	•	•	•
SAFETY & SECURITY					
Active Front Head Restraints ²¹	•	•	•	•	•
Air Bags ¹⁸ — Advanced multistage driver and front-passenger	•	•	•	•	•
— Driver's-side inflatable knee bolster	•	•	•	•	•
— Supplemental side-curtain for front and rear outboard occupants	•	•	•	•	•
Child Seat Anchor System (LATCH) — Mounts for 2 child seats in the 2nd row help ease the installation of compatible aftermarket child seats	•	•	•	•	•
Electronic Stability Control (ESC) ³ — Includes Brake Assist, Rain Brake Support, Ready Alert Braking, Hill Start Assist and All-Speed Traction Control	•	•	•	•	•
Front-Passenger Seat Belt Alert	•	•	•	•	•
Full-Speed Forward Collision Warning (FSFCW+) with Active Braking ¹⁷ (included with SafetyTec™ Plus Group)			p	p	p
ParkView® Rear Back-Up Camera ¹⁶	•	•	•	•	•
Remote Start System ⁴ (included with 300 Premium Group, Driver Convenience Group and Value Package)	p	p	•	•	•
SafetyTec Plus Group — Includes Advanced Brake Assist, rain-sensing windshield wipers, LaneSense® Lane Departure Warning with Lane Keep Assist; ²⁰ Auto High-Beam Headlamp Control, Full-Speed FCW with Active Braking ¹⁷ Adaptive Cruise Control (ACC) with Stop ¹⁹ multifunction exterior mirrors with power, heat, auto-dimming driver's mirror, supplemental turn signals and courtesy lamps; ParkSense® Front and Rear Park Assist ¹⁶ (requires Uconnect 4C NAV with 8.4-inch display and Navigation)			O	O	O
Security Alarm		•	•	•	•
Sentry Key® Theft Deterrent System — Antitheft engine immobilizer	•	•	•	•	•
Tire Pressure Monitoring Display — Located in the 7-inch reconfigurable Driver Information Display (DID)	•	•	•	•	•

CHRYSLER 300 SPECIFICATIONS (continued)

	300 TOURING	300 TOURING L	300S	300 LIMITED	300C
PACKAGES / EQUIPMENT GROUPS					
300 Premium Group — Includes power multifunction heated mirrors with Chrome caps, courtesy lamps, supplemental turn signals and auto-dimming driver's mirror, LED fog lamps, Uconnect® 4C NAV with 8.4-inch display and Navigation, 9 amplified speakers with a trunk-mounted subwoofer and 506-watt amplifier, ParkSense® Front and Rear Park Assist, ¹⁶ Blind Spot Monitoring (BSM) ¹⁵ and Rear Cross-Path Detection, ¹⁶ Remote Start ⁴ and Universal Garage Door Opener and 5-year SiriusXM® Traffic ⁹ and SiriusXM Travel Link ⁹ service (not available with Driver Convenience Group); all vehicles include SiriusXM Guardian ^{TM10} with 1-year trial subscription		○			
300S Premium Group — Includes dual-pane panoramic sunroof, power multifunction heated body-color mirrors, courtesy lamps, supplemental turn signals and auto-dimming driver's mirror, BSM ¹⁵ and Rear Cross-Path Detection, ¹⁶ Uconnect 4C NAV with 8.4-inch display and Navigation, and ParkSense Front and Rear Park Assist ¹⁶			○		
300S Premium Group 2 — Includes power multifunction manual folding mirrors with auto-adjust-in-Reverse driver's mirrors, auto-dimming exterior driver's mirror, supplemental turn signals and courtesy lamps, ventilated leather-trimmed seats, adaptive Bi-xenon High Intensity Discharge (HID) headlamps with automatic leveling system, door sill scuff pads, trunk mat, driver's and front-passenger footwell LED lamps, front and rear LED-illuminated map pockets, heated rear seats, heated steering wheel, power backlight sunshade, power tilt/telescoping steering column, memory for radio, driver's seat and mirrors, ParkSense Front and Rear Park Assist, ¹⁶ and BSM ¹⁵ and Rear Cross-Path Detection ¹⁶ ; requires Black or Black/Smoke interior colors or Black/Caramel interior if Alloy Edition			○		
Alloy Edition — Includes Titanium exhaust tips, Alloy Edition floor mats, Liquid Titanium Chrome wing badge, Dark Bronze badging, Dark Bronze grille and grille surround, 20-inch painted Dark Bronze aluminum wheels (Rear-Wheel Drive (RWD)) or 19-inch painted Dark Bronze aluminum wheels (All-Wheel Drive (AWD)); requires Black/Caramel interior			○		
Alpine® Audio Group with a subwoofer — Includes 9 amplified speakers, Surround Sound, a trunk-mounted subwoofer and 506-watt amplifier			○		
Chrome Appearance Package — Includes Chrome-capped power heated mirrors, Chrysler badging, Chrome daylight opening (DLO) molding, Platinum grille with Platinum surround and 20-inch polished aluminum wheels (restrictions apply)	○				
Driver Convenience Group — Includes 18-inch polished aluminum wheels on RWD, front LED fog lamps, Remote Start ⁴ and Universal Garage Door Opener	○				
Driver Convenience Group — Includes Uconnect 4C NAV with 8.4-inch display and Navigation, front LED fog lamps, Remote Start ⁴ and Universal Garage Door Opener (not available with 300 Premium Group)		○			
Harman Kardon® Audio Group — Includes 19 high-performance speakers, including a subwoofer and 900-watt amplifier (not available with power backlight sunshade)				○	○
Light Group — Adaptive Bi-xenon HID headlamps with auto-leveling				○	
S Model Appearance Package — Premium SRT® fog lamps, SRT body-color front fascia and appliqué, lower grille close-out panels and rear body-color spoiler, and Black Chrome grille surround when ordered without Alloy Edition (included with 5.7L HEMI® V8 engine)			○/P		
Sport Appearance Package — Includes bright Chrome wing badge with Black insert, Black LED taillamps, Black headlamp bezels, Gloss Black DLO molding, Black Chrome surround 300S grille on RWD/AWD; 20-inch Black Noise aluminum wheels and compact spare on RWD, 19-inch on AWD (not available with Chrome Appearance Package or 300 Premium Group)	○				
Sun, Sound and NAV Package — Includes dual-pane panoramic sunroof, 19 Harman Kardon speakers, Harman Kardon amplifier, Uconnect 4C NAV with 8.4-inch touchscreen display and Navigation (not available with power backlight sunshade)					○
Value Package — Includes dual-pane panoramic sunroof, LED fog lamps, Uconnect 4C NAV with 8.4-inch display and Navigation, Remote Start ⁴ and Universal Garage Door Opener (not available with Driver Convenience Group and 300 Premium Group)		○			

• = Standard ○ = Optional P = Available within package

300 DIMENSIONS (INCHES)

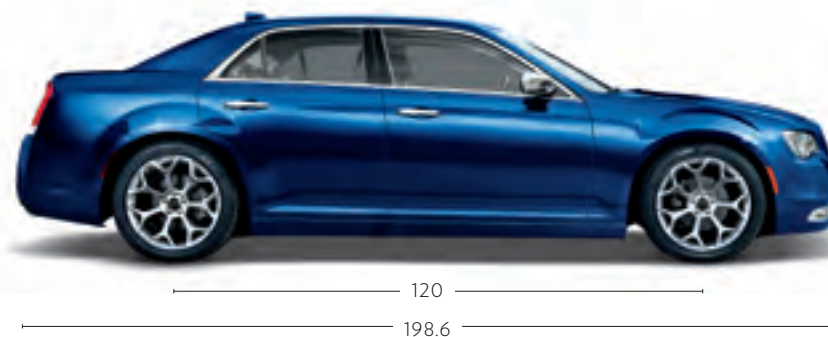



“THE REAL SECRET OF SUCCESS IS ENTHUSIASM.”

Walter Chrysler, Founder



WARRANTIES

Chrysler Brand vehicles are covered by an FCA US LLC 3-Year or 36,000-Mile Basic Limited Warranty²² (excludes normal maintenance and wear items), as well as a 5-Year or 60,000-Mile Powertrain Limited Warranty²³ that is fully transferable and includes Roadside Assistance services: Flat Tire, Lockout, Towing, Out of Gas / Fuel Delivery and Battery Jump Assistance. Ask your dealer for details and a copy of these limited warranties.^{22, 23}

AUTOMOBILITY PROGRAM

The FCA US LLC Automobility Program provides aftermarket reimbursement incentives on adaptive vehicle upfit equipment in order to help provide safe and reliable vehicle modifications to enhance accessibility for all people. For more information, call (800) 255-9877 or visit fcausautomobility.com

SIRIUSXM® RADIO⁹

SiriusXM Radio⁹ delivers over 160 channels, including commercial-free music, sports, news, talk, entertainment, traffic and weather. Factory-installed SiriusXM Radio⁹ includes a one-year subscription. SiriusXM Radio⁹ and SiriusXM Guardian™¹⁰ provide emergency, remote and security services. SiriusXM Guardian¹⁰ includes a one-year trial subscription. For more information, go to siriusxm.com

OFFICIAL CHRYSLER OWNER SITE AND APP

Your Chrysler Brand vehicle ownership gives you exclusive access to personalized vehicle information, service and maintenance records, recall notifications, roadside assistance, special offers and more through whatever device you prefer – desktop, tablet or smartphone! Register for your Chrysler Vehicle Owner Site account at mopar.com/chrysler or download the **Chrysler For Owners app** for free at either the App or Google Play stores.

MOPAR® VEHICLE PROTECTION

Mopar Vehicle Protection[®] has a vested interest in your satisfaction and owner experience with your new Chrysler Brand vehicle. This is the only extended protection provider backed by the manufacturer, FCA US LLC. We stand behind every Mopar Vehicle Protection plan with certified, factory-trained technicians and the use of authentic Mopar parts. Your plan is honored at over 2,600 dealerships within the United States, Canada, Puerto Rico and Mexico. Be sure to ask for a Mopar Vehicle Protection plan at your dealership, call (800) 442-2666 or visit moparvehicleprotection.com

JOIN IN

Join fellow enthusiasts and tell your story by posting comments, participating in discussions, and sharing your Chrysler vehicle photos and videos. Join our community on Facebook (facebook.com/Chrysler), follow us on Twitter (twitter.com/Chrysler), YouTube (youtube.com/TheChryslerChannel), Google+ (plus.google.com/+Chrysler) and check us out on Instagram (instagram.com/Chrysler). Thank you for following.

GO MOBILE

Take an engaging, multimedia tour of your Chrysler 300 on your mobile device. Log on to the Chrysler.com mobile site for a comprehensive, at-a-glance review of what you need to know about your vehicle. Experience interactive demonstrations of the entire lineup, gaining access to product information at your fingertips, wherever you go.

DRIVE PLUSSM MASTERCARD^{®24}

Earn 3 points per \$1 on qualifying purchases made at FCA US LLC dealerships, 2 points per \$1 on qualifying travel purchases and 1 point per \$1 on qualifying purchases everywhere else with the new Chrysler MasterCard²⁴. Points may be redeemed at your local dealership for cash off your new or used vehicle, accessories, parts or service – including your next oil change. Or choose from hundreds of other rewards, including travel, cash back to your account, merchandise or gift cards²⁴. For more information or to apply, visit ChryslerCard.com

CHRYSLER MERCHANDISE

Bring Chrysler Brand distinction to your lifestyle both in and outside your vehicle with apparel, personal accessories, gift cards and more. Shop the complete line at collection.chrysler.com



AUTHENTIC CHRYSLER

ACCESSORIES

The Chrysler 300 embodies classic, sophisticated design. A wide range of Authentic Mopar® Accessories, crafted specifically for the versatility of the modern 300, lets you take your lifestyle further. From performance and styling enhancements to technological conveniences and Premium Protection Parts, Mopar keeps you looking good to go. Visit your local Chrysler Brand dealership to see the full line of Authentic Accessories for all of the Chrysler 300 models.



mopar.com

Vehicle is shown with Matte Black Pinstripe Graphic, Mopar Performance Emblem and Mopar Blue Caliper Cover Kit.

(1) The Uconnect Phone requires a mobile phone equipped with the Bluetooth Hands-Free Profile. To check phone compatibility, please visit www.UconnectPhone.com. (2) Based on the FCA US LLC Upper Large Car Segmentation. (3) Always drive carefully, consistent with conditions. Always wear your seat belt and obey traffic laws. (4) Check state and local laws regarding the use of remote start systems. (5) Requires compatible iPhone. See dealer for phone compatibility. Data plan rates apply. Vehicle user interface is a product of Apple. Apple CarPlay is a trademark of Apple Inc. iPhone is a trademark of Apple Inc., registered in the US and other countries. Apple terms of use and privacy statements apply. (6) Requires an iPhone with Siri. Certain features are not available while the vehicle is in motion. iPhone must be within active cellular range. Customer's existing iPhone data rates apply to Internet-supported features. (7) To use Android Auto on your phone screen, you'll need an Android phone running 5.0 (Lollipop) or higher and the Android Auto app. Google, Android, Android Auto, YouTube and other related marks and logos are trademarks of Google LLC. (8) Three-month/1GB trial included with the purchase or lease of a new vehicle. Upon expiration of the trial period, purchase of a subscription is required. Wi-Fi Hotspot available through third-party subscription. Requires Internet-enabled mobile device. See dealer for details. This feature is not intended for use by the driver while the vehicle is in motion. Always drive carefully. (9) SiriusXM satellite radio, SiriusXM Traffic and SiriusXM Travel Link each require a subscription, sold separately or as a package, by Sirius XM Radio Inc. **If you decide to continue service after your trial period included with the new vehicle purchase, the subscription plan you choose will automatically renew thereafter and you will be charged according to your chosen payment method at then-current rates.** Trial service is not transferable. Fees and taxes apply. Please see the Customer Agreement at www.siriusxm.com for complete terms and how to cancel, which includes calling SiriusXM at 1-866-635-2349. All fees and programming are subject to change. Not all vehicles or devices are capable of receiving all services offered by SiriusXM. Data displays and individual product availability vary by vehicle hardware. Current information and features may not be available in all locations, or on all receivers. Weather Forecast. Current Conditions may not be available in all locations. (10) All SiriusXM Guardian-equipped vehicles come with a 12-month trial effective on the date of purchase or lease of a new vehicle. Enrollment in the trial is required to receive service. Upon expiration of the trial period, purchase of a subscription is required to continue SiriusXM Guardian. SiriusXM Guardian is available only on equipped vehicles purchased within the United States, Canada and Puerto Rico. Services can only be used where cellular coverage is available. See Uconnect and SiriusXM Guardian Terms of Service for complete service limitations. (11) In the event of a medical or other emergency, press the SOS button to be connected to a Customer Care agent who can direct emergency assistance to your vehicle's location. (12) Roadside Assistance Call provides direct calling to Roadside Assistance Service. Vehicle must be within the United States, Puerto Rico or Canada and have network coverage. Additional roadside assistance charges may apply. Check warranty for details. (13) To use Vehicle Finder, you must have the Uconnect App with SiriusXM Guardian installed on a compatible smartphone and have an active subscription to SiriusXM Guardian. (14) Stolen vehicle police report required. (15) Always check visually for vehicles prior to changing lanes. (16) Always look before proceeding. An electronic drive aid is not a substitute for conscientious driving. Always be aware of your surroundings. (17) This system is an alert system for the front of the vehicle. It is not a substitute for active driver involvement. The driver must remain aware of traffic conditions and be prepared to use brakes to avoid collisions. (18) Always sit properly in designated seating positions with seat belts securely fastened at all times. (19) This system is a driver convenience system, not a substitute for active driver involvement. The driver must remain aware of traffic conditions and be prepared to use the brakes to avoid collisions. (20) This system is a driver convenience system, not a substitute for active driver involvement. The driver must remain aware of traffic conditions and maintain control of the vehicle. (21) Always sit properly with the head restraint properly adjusted. Never place anything in front of the head restraint. (22) Visit Mopar.com for complete details and a copy of the 3-Year/36,000-Mile Basic Limited Warranty. (23) Visit Mopar.com for complete details and a copy of the 5-Year/60,000-Mile Powertrain Limited Warranty. (24) See the Reward Terms and Conditions in the Summary of Credit Terms provided at time of application for details, including earning, redemption, expiration or forfeiture. Percentage back is earned as points.

©2018 FCA US LLC. All Rights Reserved. Chrysler, Chrysler 300S, 300C, 300 Limited, 300 Touring, Dodge, Jeep, Ram, Mopar, SRT, the Chrysler wing design, Automobile Program, HEMI, Imported From Detroit, LaneSense, Mopar Vehicle Protection, ParkSense, ParkView, Pentastar, Sentry Key and Uconnect are registered trademarks, and Keyless Enter 'n Go and SafetyTec are trademarks of FCA US LLC.

Alpine and the Alpine logo are registered trademarks of Alpine Electronics, Inc. All rights reserved. Alcantara is a registered trademark of Alcantara S.p.A. Apple CarPlay is a trademark, and Apple Music, Apple Experience, iOS, iPhone and Siri are registered trademarks of Apple Inc. AT&T is a registered trademark of AT&T Knowledge Ventures. Bluetooth is a registered trademark of Bluetooth SIG, Inc. Facebook and logo are registered trademarks of Facebook, Inc. Google, Android, Android Auto, and other related marks and logos are trademarks of Google LLC. Harman Kardon and Logic 7 are registered trademarks and GreenEdge is a trademark of Harman International Industries, Inc. Instagram is a registered trademark of Instagram, Inc. Mastercard Cards are issued by First Bankcard, a division of First National Bank of Omaha pursuant to a license from Mastercard International Incorporated. Mastercard is a registered trademark, and the circles design is a trademark of Mastercard International Incorporated. SiriusXM Connected Vehicles Services Inc., Sirius, XM, SiriusXM and SiriusXM Guardian and all related marks and logos are registered trademarks of SiriusXM Radio Inc. The Twitter name, logo, Twitter T, Tweet and Twitter bird are service marks of Twitter, Inc. in the United States and other countries.

This brochure is a publication of FCA US LLC. All product illustrations and specifications are based upon current information at the time of publication approval. FCA US LLC reserves the right to make changes from time to time, without notice or obligation, in prices, specifications, colors and materials, and to change or discontinue models, which are considered necessary to the purpose of product improvement or for reasons of design and/or marketing.



1 800 CHRYSLER

CHRYSLER.COM

CHRYSLER IS A REGISTERED TRADEMARK OF FCA US LLC

(74-383-1912)